

GUIDA ALL' ACQUISTO

Divisione bagno

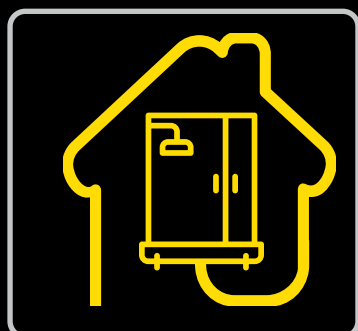

Box & piatti doccia
Sistemi di scarico
Complementi doccia

Prodotti, soluzioni
& accessori

FERRARI

www.ferrariwelcome.it



Inquadra i QR code presenti in alcune pagine di questo catalogo per avere maggiori informazioni sul prodotto, schede tecniche, video esplicativi e tanto altro!



Inquadra questo QR code per essere sempre aggiornato sulle modifiche tecniche, errata corrige, novità prodotti, ecc.



Ferrari s.r.l. dichiara che i prodotti qui inseriti sono realizzati a regola d'arte e, dove richiesto, sono certificati per l'idoneità di utilizzo secondo le norme vigenti. I prodotti nel presente catalogo sono da intendersi ad esclusivo uso professionale e destinati a soggetti in possesso della professionalità richiesta per il tipo di prodotto, con espressa esclusione dei consumatori. La buona rispondenza dei materiali agli usi espressamente indicati è condizionata alla corretta installazione oltre che al corretto dimensionamento ed utilizzo degli accessori previsto dalle norme. La nostra responsabilità è limitata alla qualità dei materiali; le illustrazioni, le foto, le misure e quant'altro indicato non sono impegnative e possono variare senza alcun obbligo di preavviso.



Sono la **passione** e la **curiosità** a guidare l'innovazione.

Se non si ha **passione**, non si ha **energia**.

Questi principi sono gli elementi che caratterizzano, da oltre 60 anni, tutto il nostro team composto da molti collaboratori di "lungo corso" e da giovani risorse che creano il giusto mix ricco di esperienza e professionalità proiettato verso il futuro portandoci a sviluppare servizi, proposte e soluzioni al passo con i tempi.

La **passione** è l'elemento trainante, una continua evoluzione e ricerca dedicata a supportare i continui cambiamenti del nostro mercato, un confronto costruttivo e continuo con tutti i nostri clienti, partner e collaboratori.

La **curiosità** ci porta ad esplorare nuovi settori, consentendoci di accrescere le nostre competenze permettendoci di offrire prodotti innovativi che soddisfano e anticipano le esigenze del mercato.

La nuova proposta di cataloghi specifici che presentiamo segna un passo in avanti nella crescita della Ferrari; una leva importante che, attraverso una più profonda focalizzazione delle gamme di prodotti, vuole fidelizzare e supportare gli attuali clienti e collaboratori sviluppando nuove partnership.

Buona consultazione!



Linea LOFTY

quando sono i dettagli a fare la differenza

La funzionalità è il cuore di ogni ambiente domestico ma soprattutto del tuo bagno.
Se unita allo stile, il risultato è un arredo pensato per ogni necessità che non rinuncia a qualità ed estetica.
Da qui nasce la linea di box doccia LOFTY: essenziale nelle sue finiture, pratica e curata in ogni minimo dettaglio.

VANTAGGI

FACILE DA MONTARE

**CHIUSURA MAGNETICA
SILENZIATA**

**AMPIA GAMMA
DI MISURE**

REVERSIBILE

ESTENSIBILE

SGANCIO RAPIDO

ANTIBATTERICO

ANTIMUFFA

Profilo coprifissaggi



Particolare copertura



Particolare maniglia



Particolare porta soffietto



Caratteristiche

Altezza	200 cm
Cristallo	Trasparente spessore 6mm (8 mm Walk-in) Norma EN12150 -1
Profili	Alluminio cromato lucido con coprifissaggio
Maniglie	Cromate



TIPOLOGIE DISPONIBILI:



**Lato per angolo
con apertura
scorrevole laterale**



**Porta a due ante
con apertura
scorrevole laterale**



**Porta a tre ante
con apertura
scorrevole laterale**



**Porta battente
pivot**



**Porta a soffietto con
apertura interna
(esterna antipanico)**



**Parete
laterale**



**Parete
doccia Walk-in**



POSSIBILI COMBINAZIONI:

ANGOLO

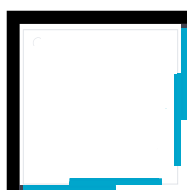

2 x LATO SCORREVOLE A DUE ANTE

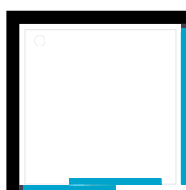

1 x LATO FISSO + 1 x PORTA SCORREVOLE A DUE ANTE



1 x LATO FISSO + 1 x PORTA SCORREVOLE A TRE ANTE



1 x LATO FISSO + 1 x PORTA A BATTENTE



1 x LATO FISSO + 1 x PORTA A SOFFIETTO

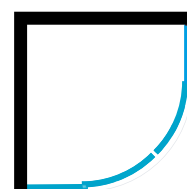

1 x ANGOLARE SEMICIRCOLARE

CENTRO PARETE



2 x LATO FISSO + 1 x PORTA SCORREVOLE A DUE ANTE



2 x LATO FISSO + 1 x PORTA SCORREVOLE A TRE ANTE

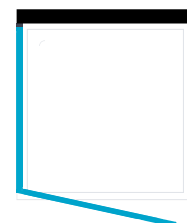

2 x LATO FISSO + 1 x PORTA A BATTENTE



2 x LATO FISSO + 1 x PORTA A SOFFIETTO



1 x LATO FISSO + 2 x LATO SCORREVOLE A DUE ANTE

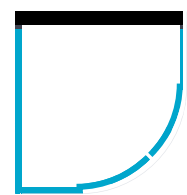

1 x LATO FISSO + 1 x ANGOLARE SEMICIRCOLARE

NICCHIA



1 x PORTA SCORREVOLE A DUE ANTE

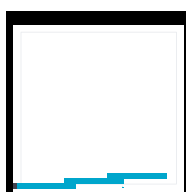

1 x PORTA SCORREVOLE A TRE ANTE

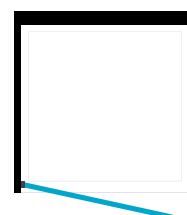

1 x PORTA A BATTENTE

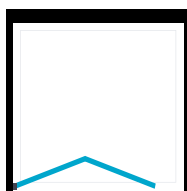

1 x PORTA A SOFFIETTO

WALK-IN

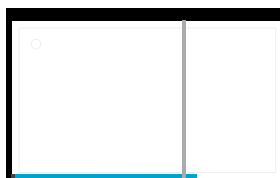

1 x WALK-IN CON BRACCIO

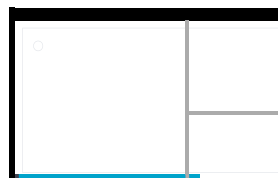

2 x WALK-IN CON 1 BRACCIO A T

**LATO PER ANGOLO
APERTURA SCORREVOLE LATERALE**



CODICE	EURO/PZ	VERSIONE		PZ
		L cm	Estensibilità cm	
601630		65	63 ÷ 65	1
601631		70	68 ÷ 70	1
601632		75	73 ÷ 75	1
601633		80	78 ÷ 80	1
601634		90	88 ÷ 90	1
601635		100	98 ÷ 100	1
601636		110	108 ÷ 110	1
601637		120	118 ÷ 120	1
601638		130	128 ÷ 130	1
601639		140	138 ÷ 140	1



Esempio con 2 lati
angolari

Linea LOFTY

PORTA A DUE ANTE
CON APERTURA SCORREVOLE LATERALE



BOX DOCCIA

Linea LOFTY



Esempio con parete laterale

CODICE	EURO/PZ	VERSIONE			PZ
		L cm	Estensibilità cm	Ingresso cm	
601640		100	96 ÷ 100	42	1
601641		110	106 ÷ 110	46	1
601642		120	116 ÷ 120	51	1
601643		140	136 ÷ 140	60	1
601663		150	146 ÷ 150	65	1
601644		160	156 ÷ 160	70	1
601645		170	166 ÷ 170	75	1

Linea LOFTY

**PORTA SCORREVOLE A TRE ANTE
CON APERTURA SCORREVOLE LATERALE**



Esempio con parete laterale

CODICE	EURO/PZ	VERSIONE			PZ
		L cm	Estensibilità cm	Ingresso cm	
601646		100	96 ÷ 100	52	1
601647		110	106 ÷ 110	58	1
601648		120	116 ÷ 120	65	1

Linea LOFTY

PORTA BATTENTE PIVOT



BOX DOCCIA

Linea LOFTY

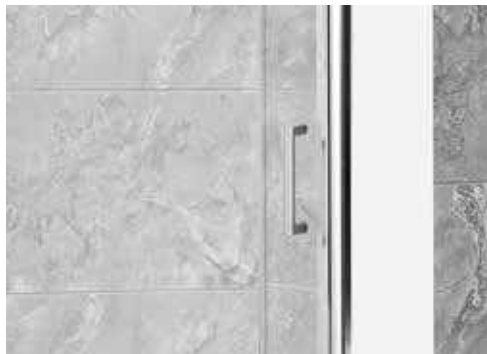

CODICE	EURO/PZ	VERSIONE			PZ
		L cm	Estensibilità cm	Ingresso cm	
601649		70	66 ÷ 70	58	1
601650		75	71 ÷ 75	63	1
601651		80	76 ÷ 80	68	1
601652		90	86 ÷ 90	78	1

Linea LOFTY

PORTA A SOFFIETTO
CON APERTURA INTERNO/ESTERNO (ANTIPANICO)



CODICE	EURO/PZ	VERSIONE			PZ
		L cm	Estensibilità cm	Ingresso cm	
601653		70	66 ÷ 70	42	1
601654		75	71 ÷ 75	46	1
601655		80	76 ÷ 80	49,5	1
601656		90	86 ÷ 90	57	1
601665		100	96 ÷ 100	65	1



Esempio apertura esterna
(antipanico)

Linea LOFTY

ANGOLARE SEMICIRCOLARE
CON APERTURA CENTRALE (R. 55 CM)



BOX DOCCIA

Linea LOFTY



Apertura centrale

CODICE	EURO/PZ	VERSIONE			PZ
		L cm	Estensibilità cm	Ingresso cm	
601657		80x80	78 ÷ 80 x 78 ÷ 80	46	1
601658		90x90	88 ÷ 90 x 88 ÷ 90	52	1

Linea LOFTY

PARETE LATERALE



CODICE	EURO/PZ	VERSIONE		PZ
		L cm	Estensibilità cm	
601659		70	68 ÷ 70	1
601660		75	73 ÷ 75	1
601661		80	78 ÷ 80	1
601662		90	88 ÷ 90	1

Linea LOFTY

PARETE DOCCIA WALK IN

Spessore cristallo: **8 mm**, braccetto stabilizzatore telescopico in ottone cromato cm 100 incluso



Esempio WALK-IN 1 lato con 1 braccio

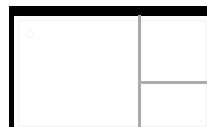

Esempio WALK-IN 2 lati con 2 bracci e raccordo

CODICE	EURO/PZ	VERSIONE		PZ
		L cm	Estensibilità cm	
601097		70	67 ÷ 69	1
601099		80	77 ÷ 79	1
601101		90	87 ÷ 89	1
601103		100	97 ÷ 99	1
601105		110	107 ÷ 109	1
601107		120	117 ÷ 119	1
601109		140	137 ÷ 139	1
601111		150	147 ÷ 149	1
601113		160	157 ÷ 159	1

RACCORDO PER DUE PARETI DOCCIA WALK - IN

CODICE	EURO/PZ	PZ
601710		1



COPPIA DI CUSCINETTI SCORREVOLI

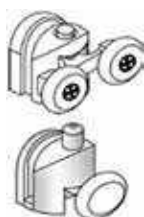

Coppia di cuscinetti scorrevoli uno superiore e uno inferiore.
Per modelli:
 angolo - semicircolare
 porta scorrevole

CODICE	EURO/CONF.	PZ.
601695		1

PROFILO DI COMPENAZIONE

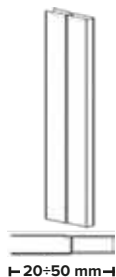

Per modelli:
 angolo - semicircolare - porta scorrevole - porta pivot scorrevole a tre ante
 porta a soffietto - parete laterale

CODICE	EURO/PZ	PZ.
601690		1

PROFILO MURO

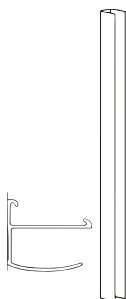

Per modelli:
 angolo - semicircolare - porta scorrevole - porta pivot scorrevole a tre ante
 porta a soffietto - parete laterale

CODICE	EURO/PZ	PZ.
601708		1

PROFILO COPRIFISSAGGI



Per modelli:
 angolo - semicircolare - porta scorrevole - porta pivot scorrevole a tre ante
 porta a soffietto - parete laterale

CODICE	EURO/PZ	PZ.
601691		1

KIT DI GIUNZIONE ANGOLARE

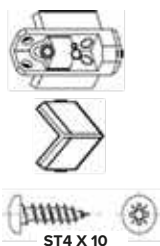

Per modelli: angolo

CODICE	EURO/PZ	PZ.
601707		1

KIT DI FISSAGGIO PROFILO A MURO

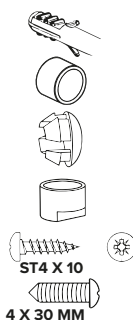

Per modelli:
 angolo - semicircolare
 porta scorrevole - porta pivot scorrevole a tre ante
 porta a soffietto - parete laterale

CODICE	EURO/PZ	PZ.
601692		1

MANIGLIA COMPLETA PER PORTA
 parte interna ed esterna



Per modelli:
 angolo - semicircolare - porta scorrevole - porta pivot scorrevole a tre ante
 porta a soffietto - parete laterale

CODICE	EURO/PZ	PZ.
601711		1

KIT FERMAPORTA

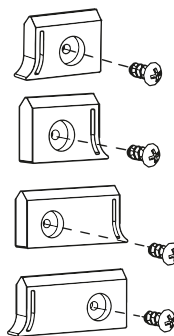

Per modelli:
 angolo - semicircolare
 porta scorrevole

CODICE	EURO/PZ	PZ.
601705		1

COPERCHI PER PROFILI VERTICALI PER MONTANTE

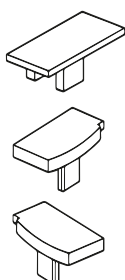

Per modelli:
 angolo - semicircolare - porta scorrevole - porta pivot scorrevole a tre ante

CODICE	EURO/PZ	PZ.
601694		1

COPERCHI PER PROFILI VERTICALI PER MONTANTE

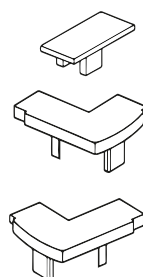

Per modello:
 parete fissa

CODICE	EURO/PZ	PZ.
601693		1

**GUARNIZIONE A BAFFO ESTERNO 1 X BOX
(L. 1820 MM)**

Per modelli:
angolo - semicircolare
porta scorrevole

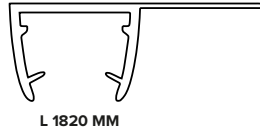

CODICE	EURO/PZ	PZ.
601703		1

**GUARNIZIONE A BAFFO INTERNO 1 X BOX
(L. 1880 MM)**

Per modelli:
angolo - semicircolare
porta scorrevole

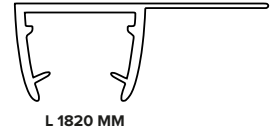

CODICE	EURO/PZ	PZ.
601702		1

GUARNIZIONE A PALLONCINO 1 X BOX

Per modelli:
angolo - semicircolare
porta scorrevole

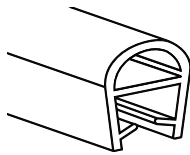

CODICE	EURO/PZ	PZ.
601699		1

**GUARNIZIONE MAGNETICA 1 X BOX
2 PEZZI**

Per modello:
semicircolare

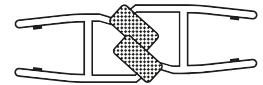

CODICE	EURO/PZ	PZ.
601698		1

**GUARNIZIONE MAGNETICA AD ANGOLO
1 X BOX**

Per modello: angolo

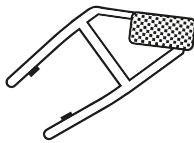

CODICE	EURO/PZ	PZ.
601697		1

**GUARNIZIONE VERTICALE PER PORTA PIVOT
1 X BOX**

Per modello:
porta pivot



CODICE	EURO/PZ	PZ.
601701		1

**GUARNIZIONE MAGNETICA PER PORTA PIVOT
1 X BOX**

Per modello:
porta pivot

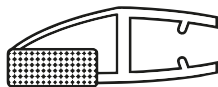

CODICE	EURO/PZ	PZ.
601700		1

**GUARNIZIONE INFERIORE PER PORTA PIVOT
1 X BOX**

Per modello:
porta pivot

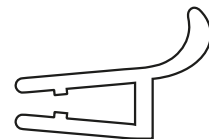

CODICE	EURO/PZ	PZ.
601696		1

**GUARNIZIONE MAGNETICA PER SCORREVOLE
1 X BOX**

Per modello:
porta scorrevole

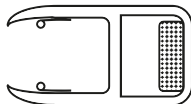

CODICE	EURO/PZ	PZ.
601704		1

**KIT DI FISSAGGIO PER PROFILO
DI COMPENSAZIONE**

Per modelli:
angolo - semicircolare
porta scorrevole - porta pivot
scorrevole a tre ante
porta a soffietto - parete laterale

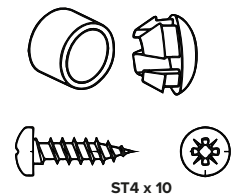

ST4 x 10

CODICE	EURO/PZ	PZ.
601706		1

**ANGOLO DOCCIA
CON APERTURA SCORREVOLE LATERALE**



Caratteristiche

Altezza	185 cm
Pannello	spessore 1,8 mm
Profili	PVC bianco pastello
Chiusure	magnetiche



CODICE	EURO/PZ	VERSIONE		PZ
		Dimensioni cm	Ingresso cm	
601800		70÷65 x 70÷65	38	1
601801		70÷65 x 90÷85	46	1
601802		70÷65 x 100÷105	50	1
601803		70÷65 x 120÷115	58	1
601804		75÷70 x 75÷70	42	1
601805		75÷70 x 90÷85	47	1
601806		80÷75 x 80÷75	45	1
601807		80÷75 x 100÷95	53	1
601808		80÷75 x 120÷115	61	1
601809		90÷85 x 90÷85	52	1
601810		100÷75 x 100÷95	59	1

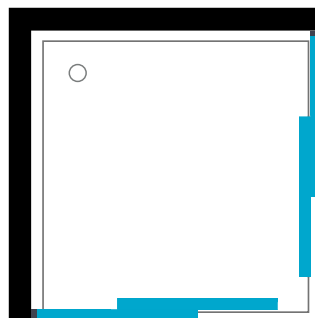

Linea ACRIL

ESTENSIBILE - REVERSIBILE - RIDUCIBILE



BOX DOCCIA

Linea ACRIL

PORTA SCORREVOLE A DUE ANTE PER NICCHIA CON APERTURA SCORREVOLE LATERALE

Caratteristiche

Altezza	185 cm
Pannello	spessore 1,8 mm
Profili	PVC bianco pastello
Chiusure	magnetiche

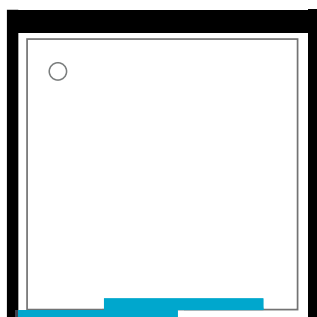

CODICE	EURO/PZ	VERSIONE		PZ
		Dimensioni cm	Ingresso cm	
601815		100÷90	42	1
601816		110÷100	47	1
601817		120÷110	52	1
601818		130÷120	57	1
601819		140÷130	62	1
601820		150÷140	66	1

Linea ACRIL
ESTENSIBILE - REVERSIBILE - RIDUCIBILE

PARETE LATERALE



Caratteristiche

Altezza	185 cm
Pannello	spessore 1,8 mm
Profili	PVC bianco pastello
Chiusure	magnetiche



CODICE	EURO/PZ	VERSIONE Dimensioni cm	PZ
601825		67÷70	1
601826		72÷75	1
601827		77÷80	1
601828		87÷90	1

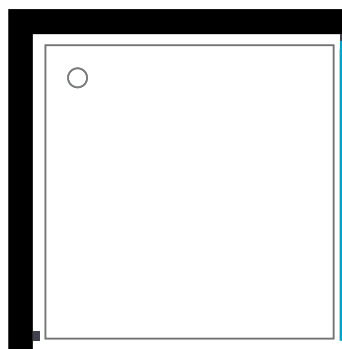

Linea ACRIL

ESTENSIBILE - REVERSIBILE - RIDUCIBILE



BOX DOCCIA

Linea ACRIL

ANGOLARE DOCCIA SEMICIRCOLARE CON APERTURA CENTRALE (R. 55 CM)

Caratteristiche

Altezza	185 cm
Pannello	spessore 2,2 mm
Profili	PVC bianco pastello
Chiusure	magnetiche

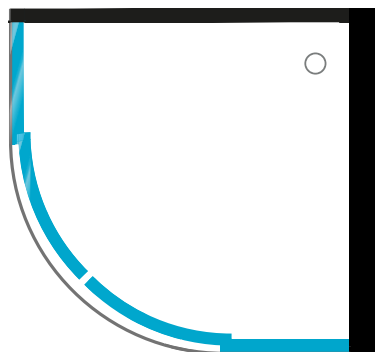

CODICE	EURO/PZ	VERSIONE		PZ
		Dimensioni cm	Ingresso cm	
601835		80÷75 x 80÷75	48	1
601836		90÷85 x 90÷85	55	1
601837		100÷95 x 100÷95	62	1

PIATTO DOCCIA
ZERO Mineral Plane

Design, stile e funzionalità si incontrano per dar vita a questa collezione unica e moderna

I piatti doccia **extra piani ZERO** sono fabbricati con una base strutturale, realizzata con una carica minerale ottenuta dalla miscelazione di Dolomia e Silice tixotropica e resina poliestere isoftalica. Tale base strutturale viene ricoperta con un particolare e spesso strato di gel coat di resina poliestere ISO NPG lavorata con una particolare tecnologia implementata direttamente dal produttore. La particolare composizione della carica minerale della struttura, **priva di carbonato di calcio**, garantisce uniformità, stabilità dimensionale, forte resistenza alle sollecitazioni meccaniche, termiche e alla corrosione. Il rivestimento del particolare gel coat ISO NPG inoltre garantisce una grande resistenza all'usura e agli urti accidentali e una Classe 3 antiscivolo.

Disponibili in 4 colori standard e 47 misure.
 Texture : ardesia

VANTAGGI

ANTISCIVOLO CLASSE 3	RESISTE AI RAGGI UV	BORDI RIFINITI TAGLIABILI	35% DI PESO RIDOTTO	FACILE DA PULIRE ESELENTE DA IDROLISI
ANTIBATTERICO	RIPARABILE	ELEVATA DUREZZA	TAGLIABILE	

Caratteristiche

Materiale	resina e carica minerale e miscela oftalmica
Copertura	gel coat spessore 2,5÷2,7 mm
Antiscivolo	UNE ENV 12633 - Classe 3
Idoneità pulizia e durata	UNE EN 14527 - Class 1
Durezza Barcol	4,5
Soglia tolleranza curvatura	0,3%
Scarico sifone	orizzontale c/fissaggio a ghiera a tre viti
Capacità di scarico sifone	58 litri/min
Griglia	inossidabile - in tinta con il piatto

DIMENSIONI PIATTO

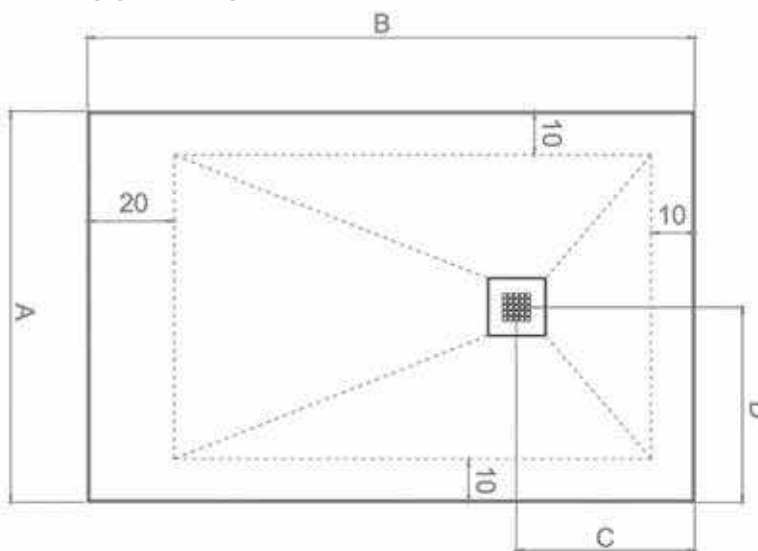

A	B	C	D
70	90 / 100 / 120 / 130 / 140 / 150 / 160	41	35
	170 / 180 / 200	61	
75	100 / 120 / 130 / 140 / 150 / 160	41	37,5
	170 / 180	61	
80	80	40	40
	90 / 100 / 120 / 130 / 140 / 150 / 160	41	
	170 / 180 / 200	61	
	90	45	
90	100	50	45
	120 / 140	45	
	160	41	
	180/200	61	
100	100	50	50
	120 / 140	45	
	160/ 180/200	61	
	215	77	
110	200	61	55

(Quote in cm)

2'5 - 2,7 cm



DIMENSIONI SIFONE



VALVOLA INCLUSA
58 litri/min

**GRIGLIA IN TINTA CON IL PIATTO
INCLUSA**

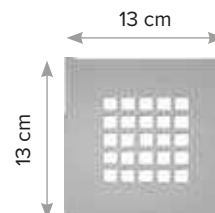

FINITURE



Piatto doccia ZERO - 700 mm

CODICE	EURO/PZ	VERSIONE		PZ
		Dimensioni mm	Finitura	
602000		700 x 900	bianco	1
602001			cemento	1
602002			antracite	1
602003			corda	1

CODICE	EURO/PZ	VERSIONE		PZ
		Dimensioni mm	Finitura	
602005		700 x 1000	bianco	1
602006			cemento	1
602007			antracite	1
602008			corda	1

CODICE	EURO/PZ	VERSIONE		PZ
		Dimensioni mm	Finitura	
602015		700 x 1200	bianco	1
602016			cemento	1
602017			antracite	1
602018			corda	1

CODICE	EURO/PZ	VERSIONE		PZ
		Dimensioni mm	Finitura	
602020		700 x 1300	bianco	1
602021			cemento	1
602022			antracite	1
602023			corda	1

CODICE	EURO/PZ	VERSIONE		PZ
		Dimensioni mm	Finitura	
602025		700 x 1400	bianco	1
602026			cemento	1
602027			antracite	1
602028			corda	1

CODICE	EURO/PZ	VERSIONE		PZ
		Dimensioni mm	Finitura	
602030		700 x 1500	bianco	1
602031			cemento	1
602032			antracite	1
602033			corda	1

CODICE	EURO/PZ	VERSIONE		PZ
		Dimensioni mm	Finitura	
602035		700 x 1600	bianco	1
602036			cemento	1
602037			antracite	1
602038			corda	1

CODICE	EURO/PZ	VERSIONE		PZ
		Dimensioni mm	Finitura	
602040		700 x 1700	bianco	1
602041			cemento	1
602042			antracite	1
602043			corda	1

CODICE	EURO/PZ	VERSIONE		PZ
		Dimensioni mm	Finitura	
602045		700 x 1800	bianco	1
602046			cemento	1
602047			antracite	1
602048			corda	1

CODICE	EURO/PZ	VERSIONE		PZ
		Dimensioni mm	Finitura	
602050		700 x 2000	bianco	1
602051			cemento	1
602052			antracite	1
602053			corda	1

Piatto doccia ZERO - 750 mm

CODICE	EURO/PZ	VERSIONE		PZ
		Dimensioni mm	Finitura	
602060		750 x 1000	bianco	1
602061			cemento	1
602062			antracite	1
602063			corda	1

CODICE	EURO/PZ	VERSIONE		PZ
		Dimensioni mm	Finitura	
602070		750 x 1200	bianco	1
602071			cemento	1
602072			antracite	1
602073			corda	1

CODICE	EURO/PZ	VERSIONE		PZ
		Dimensioni mm	Finitura	
602075		750 x 1300	bianco	1
602076			cemento	1
602077			antracite	1
602078			corda	1

CODICE	EURO/PZ	VERSIONE		PZ
		Dimensioni mm	Finitura	
602080		750 x 1400	bianco	1
602081			cemento	1
602082			antracite	1
602083			corda	1

CODICE	EURO/PZ	VERSIONE		PZ
		Dimensioni mm	Finitura	
602085		750 x 1500	bianco	1
602086			cemento	1
602087			antracite	1
602088			corda	1

CODICE	EURO/PZ	VERSIONE		PZ
		Dimensioni mm	Finitura	
602090		750 x 1600	bianco	1
602091			cemento	1
602092			antracite	1
602093			corda	1



CODICE	EURO/PZ	VERSIONE		PZ
		Dimensioni mm	Finitura	
602095		750 x 1700	bianco	1
602096			cemento	1
602097			antracite	1
602098			corda	1

CODICE	EURO/PZ	VERSIONE		PZ
		Dimensioni mm	Finitura	
602100		750 x 1800	bianco	1
602101			cemento	1
602102			antracite	1
602103			corda	1

Piatto doccia ZERO - 800 mm

CODICE	EURO/PZ	VERSIONE		PZ
		Dimensioni mm	Finitura	
602110		800 x 800	bianco	1
602111			cemento	1
602112			antracite	1
602113			corda	1

CODICE	EURO/PZ	VERSIONE		PZ
		Dimensioni mm	Finitura	
602115		800 x 900	bianco	1
602116			cemento	1
602117			antracite	1
602118			corda	1

CODICE	EURO/PZ	VERSIONE		PZ
		Dimensioni mm	Finitura	
602120		800 x 1000	bianco	1
602121			cemento	1
602122			antracite	1
602123			corda	1

CODICE	EURO/PZ	VERSIONE		PZ
		Dimensioni mm	Finitura	
602130		800 x 1200	bianco	1
602131			cemento	1
602132			antracite	1
602133			corda	1

CODICE	EURO/PZ	VERSIONE		PZ
		Dimensioni mm	Finitura	
602135		800 x 1300	bianco	1
602136			cemento	1
602137			antracite	1
602138			corda	1

CODICE	EURO/PZ	VERSIONE		PZ
		Dimensioni mm	Finitura	
602140		800 x 1400	bianco	1
602141			cemento	1
602142			antracite	1
602143			corda	1

CODICE	EURO/PZ	VERSIONE		PZ
		Dimensioni mm	Finitura	
602145		800 x 1500	bianco	1
602146			cemento	1
602147			antracite	1
602148			corda	1

CODICE	EURO/PZ	VERSIONE		PZ
		Dimensioni mm	Finitura	
602150		800 x 1600	bianco	1
602151			cemento	1
602152			antracite	1
602153			corda	1

CODICE	EURO/PZ	VERSIONE		PZ
		Dimensioni mm	Finitura	
602155		800 x 1700	bianco	1
602156			cemento	1
602157			antracite	1
602158			corda	1

CODICE	EURO/PZ	VERSIONE		PZ
		Dimensioni mm	Finitura	
602160		800 x 1800	bianco	1
602161			cemento	1
602162			antracite	1
602163			corda	1

CODICE	EURO/PZ	VERSIONE		PZ
		Dimensioni mm	Finitura	
602165		800 x 2000	bianco	1
602166			cemento	1
602167			antracite	1
602168			corda	1

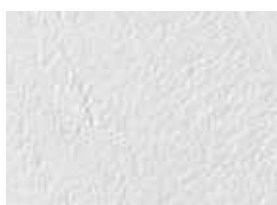
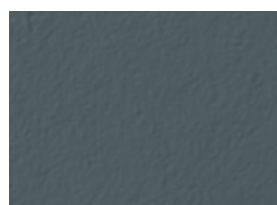
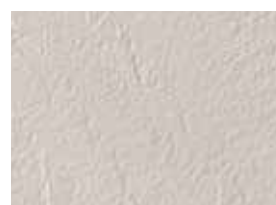
**BIANCO****CEMENTO****ANTRACITE****CORDA**

Piatto doccia ZERO - 900 mm

CODICE	EURO/PZ	VERSIONE		PZ
		Dimensioni mm	Finitura	
602170		900 x 900	bianco	1
602171			cemento	1
602172			antracite	1
602173			corda	1

CODICE	EURO/PZ	VERSIONE		PZ
		Dimensioni mm	Finitura	
602175		900 x 1000	bianco	1
602176			cemento	1
602177			antracite	1
602178			corda	1

CODICE	EURO/PZ	VERSIONE		PZ
		Dimensioni mm	Finitura	
602185		900 x 1200	bianco	1
602186			cemento	1
602187			antracite	1
602188			corda	1

CODICE	EURO/PZ	VERSIONE		PZ
		Dimensioni mm	Finitura	
602195		900 x 1400	bianco	1
602196			cemento	1
602197			antracite	1
602198			corda	1

CODICE	EURO/PZ	VERSIONE		PZ
		Dimensioni mm	Finitura	
602205		900 x 1600	bianco	1
602206			cemento	1
602207			antracite	1
602208			corda	1

CODICE	EURO/PZ	VERSIONE		PZ
		Dimensioni mm	Finitura	
602215		900 x 1800	bianco	1
602216			cemento	1
602217			antracite	1
602218			corda	1

CODICE	EURO/PZ	VERSIONE		PZ
		Dimensioni mm	Finitura	
602220		900 x 2000	bianco	1
602221			cemento	1
602222			antracite	1
602223			corda	1

Piatto doccia ZERO - Grandi formati

CODICE	EURO/PZ	VERSIONE		PZ
		Dimensioni mm	Finitura	
602225		1000 x 1000	bianco	1
602226			cemento	1
602227			antracite	1
602228			corda	1

CODICE	EURO/PZ	VERSIONE		PZ
		Dimensioni mm	Finitura	
602235		1000 x 1200	bianco	1
602236			cemento	1
602237			antracite	1
602238			corda	1

CODICE	EURO/PZ	VERSIONE		PZ
		Dimensioni mm	Finitura	
602250		1000 x 1400	bianco	1
602251			cemento	1
602252			antracite	1
602253			corda	1

CODICE	EURO/PZ	VERSIONE		PZ
		Dimensioni mm	Finitura	
602260		1000 x 1600	bianco	1
602261			cemento	1
602262			antracite	1
602263			corda	1

CODICE	EURO/PZ	VERSIONE		PZ
		Dimensioni mm	Finitura	
602270		1000 x 1800	bianco	1
602271			cemento	1
602272			antracite	1
602273			corda	1

CODICE	EURO/PZ	VERSIONE		PZ
		Dimensioni mm	Finitura	
602280		1000 x 2000	bianco	1
602281			cemento	1
602282			antracite	1
602283			corda	1

CODICE	EURO/PZ	VERSIONE		PZ
		Dimensioni mm	Finitura	
602290		1000 x 2150	bianco	1
602291			cemento	1
602292			antracite	1
602293			corda	1

CODICE	EURO/PZ	VERSIONE		PZ
		Dimensioni mm	Finitura	
602295		1100 x 2000	bianco	1
602296			cemento	1
602297			antracite	1
602298			corda	1

Piatto doccia ZERO - angolo tondo

PIATTO DOCCIA ANGOLO TONDO RAGGIO 55 CM

CODICE	EURO/PZ	VERSIONE		PZ
		Dimensioni mm	Finitura	
602315		900x900	bianco	1
602316			cemento	1
602317			antracite	1
602318			corda	1

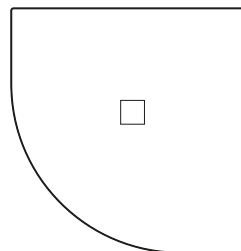

Piatto doccia ZERO - Accessori e ricambi

CODICE	EURO/PZ	VERSIONE	Peso ml	PZ
603515		Mastice in poliuretano - color bianco	300	1
603516		Mastice in poliuretano - color cemento	300	1
603517		Mastice in poliuretano - color antracite	300	1
603518		Mastice in poliuretano - color corda	300	1
602325		Kit di ripristino - piccolo - color bianco	125	1
602326		Kit di ripristino - piccolo - color cemento	125	1
602327		Kit di ripristino - piccolo - color antracite	125	1
602328		Kit di ripristino - piccolo - color corda	125	1

CODICE	EURO/PZ	VERSIONE	PZ
606152		Piletta di scarico ribassata Ø 90 mm	1
602335		Griglia in inox	1

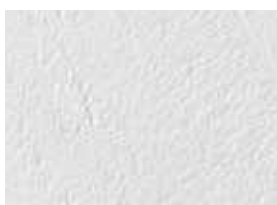
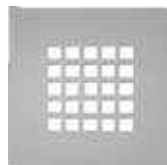

BIANCO



CEMENTO

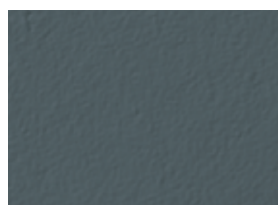

ANTRACITE



CORDA

Canalette Linea Inox Style

Piccole, grandi, quadrate, sobrie. **Inox Style** offre una linea completa di canalette di scarico per doccia a filo pavimento. Grazie all'**altezza di soli 63 mm** sono particolarmente indicate nelle ristrutturazioni.

Interamente in acciaio inox con cornice specifica per un ottimo collegamento con la guaina, liquida o morbida, a garanzia di una totale impermeabilizzazione. Concepite per poter essere installate in posizione centrale o laterale rispetto al piatto doccia (**serie Luxury**) ma anche tra il piatto doccia e la parete (**serie Ram**).

VANTAGGI

FACILE DA MONTARE	ANTIBATTERICO E ANTIMUFFA	ALTEZZA REGOLABILE	8 MISURE DISPONIBILI	8 GRIGLIE DISPONIBILI	RESISTE AI RAGGI UV	ADATTO A PERSONE CON DIFFICOLTÀ MOTORIE
--------------------------	----------------------------------	---------------------------	-----------------------------	------------------------------	----------------------------	--

Linea Luxury rettangolare e quadrata

Soluzioni di installazione: posizione centrale o laterale



SOLUZIONI DI INSTALLAZIONE

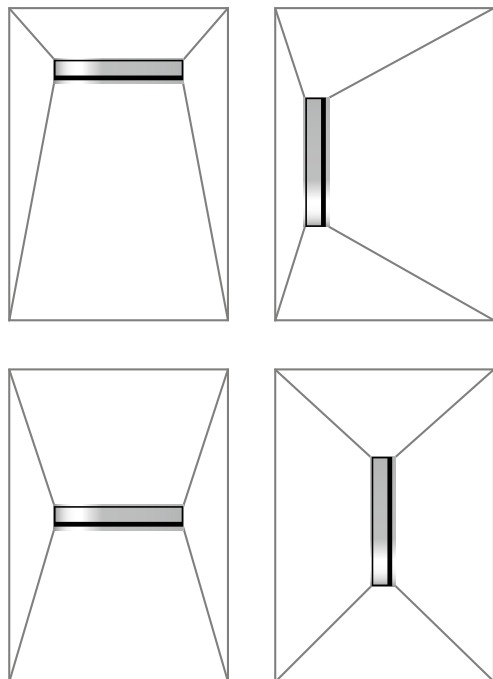

Linea Ram rettangolare e triangolare

Soluzioni di installazione: filo muro (con scarico orizzontale)



SOLUZIONI DI INSTALLAZIONE

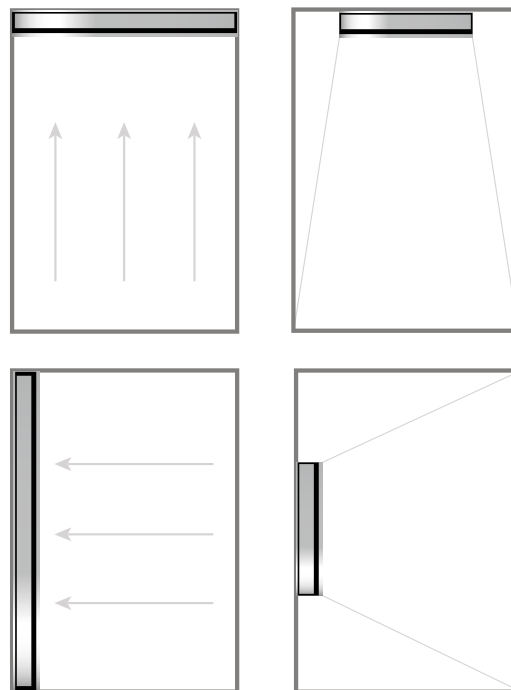

Sifone di scarico in acciaio inox incluso



SIFONE ANTIODORE VALVE
Sifone antiodore in acciaio inox progettato con valvola automatica di chiusura contro la fuoriuscita di eventuali cattivi odori Cod. 606151

Linea Luxury Rettangolare

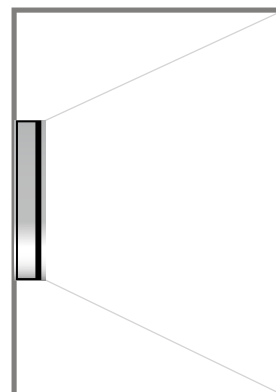
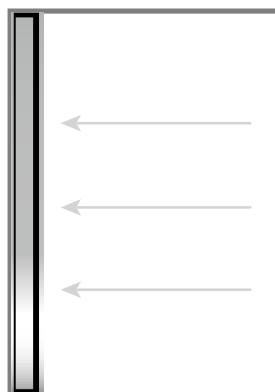
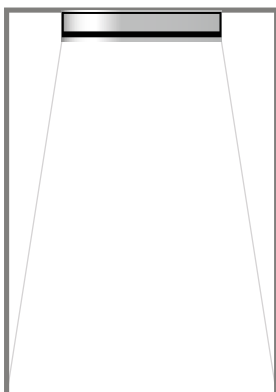
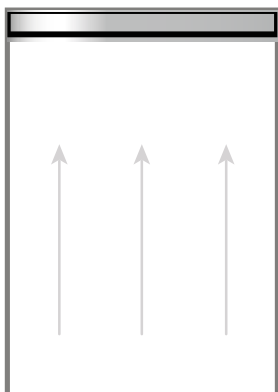

Caratteristiche

Materiale	acciaio inox spessore 20/10
Scarico	DN 50
Capacità di scarico	55 l/min
Colore	acciaio
Dimenszioni	A 80 x H 63 ÷ 115 mm

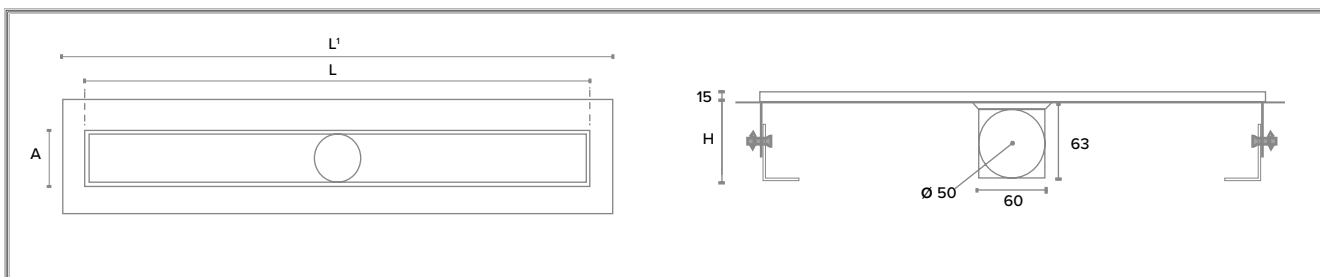

Linea Luxury Rettangolare

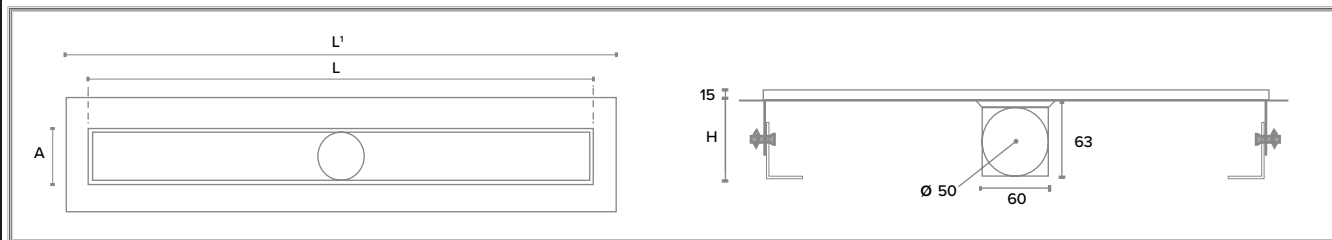

FULL INOX PIASTRELLABILE

CODICE	EURO/PZ	VERSIONE		PZ
		L (mm)	L' (mm)	
603080		485	535	1
603081		585	635	1
603082		685	735	1
603083		785	835	1
603084		885	935	1
603085		985	1035	1
603086		1085	1135	1
603087		1185	1235	1



FULL INOX LUCIDO



CODICE	EURO/PZ	VERSIONE		PZ
		L (mm)	L' (mm)	
603000		485	535	1
603001		585	635	1
603002		685	735	1
603003		785	835	1
603004		885	935	1
603005		985	1035	1
603006		1085	1135	1
603007		1185	1235	1

FULL INOX SATINATO



CODICE	EURO/PZ	VERSIONE		PZ
		L (mm)	L' (mm)	
603008		485	535	1
603009		585	635	1
603010		685	735	1
603011		785	835	1
603012		885	935	1
603013		985	1035	1
603014		1085	1135	1
603015		1185	1235	1

FULL INOX CON INCISIONE "SQUARE 1"



CODICE	EURO/PZ	VERSIONE		PZ
		L (mm)	L' (mm)	
603016		485	535	1
603017		585	635	1
603018		685	735	1
603019		785	835	1
603020		885	935	1
603021		985	1035	1
603022		1085	1135	1
603023		1185	1235	1

FULL INOX CON INCISIONE "SQUARE 2"



CODICE	EURO/PZ	VERSIONE		PZ
		L (mm)	L' (mm)	
603024		485	535	1
603025		585	635	1
603026		685	735	1
603027		785	835	1
603028		885	935	1
603029		985	1035	1
603030		1085	1135	1
603031		1185	1235	1

FULL INOX CON INCISIONE "RECTANGLES"

CODICE	EURO/PZ	VERSIONE		PZ
		L (mm)	L ¹ (mm)	
603032		485	535	1
603033		585	635	1
603034		685	735	1
603035		785	835	1
603036		885	935	1
603037		985	1035	1
603038		1085	1135	1
603039		1185	1235	1

FULL INOX CON INCISIONE "CIRCLES"

CODICE	EURO/PZ	VERSIONE		PZ
		L (mm)	L ¹ (mm)	
603040		485	535	1
603041		585	635	1
603042		685	735	1
603043		785	835	1
603044		885	935	1
603045		985	1035	1
603046		1085	1135	1
603047		1185	1235	1

FULL INOX CON LASTRA IN CRISTALLO BIANCO

CODICE	EURO/PZ	VERSIONE		PZ
		L (mm)	L ¹ (mm)	
603072		485	535	1
603073		585	635	1
603074		685	735	1
603075		785	835	1
603076		885	935	1
603077		985	1035	1
603078		1085	1135	1
603079		1185	1235	1

FULL INOX CON LASTRA IN CRISTALLO NERO

CODICE	EURO/PZ	VERSIONE		PZ
		L (mm)	L ¹ (mm)	
603064		485	535	1
603065		585	635	1
603066		685	735	1
603067		785	835	1
603068		885	935	1
603069		985	1035	1
603070		1085	1135	1
603071		1185	1235	1

FULL INOX CON INCISIONE "VENICE 1"

CODICE	EURO/PZ	VERSIONE		PZ
		L (mm)	L ¹ (mm)	
603048		485	535	1
603049		585	635	1
603050		685	735	1
603051		785	835	1
603052		885	935	1
603053		985	1035	1
603054		1085	1135	1
603055		1185	1235	1

FULL INOX CON INCISIONE "VENICE 2"

CODICE	EURO/PZ	VERSIONE		PZ
		L (mm)	L ¹ (mm)	
603056		485	535	1
603057		585	635	1
603058		685	735	1
603059		785	835	1
603060		885	935	1
603061		985	1035	1
603062		1085	1135	1
603063		1185	1235	1

SISTEMA DI SCARICO INOX STYLE

Linea RAM Rettangolare

Soluzioni di installazione: filo muro (con scarico orizzontale)

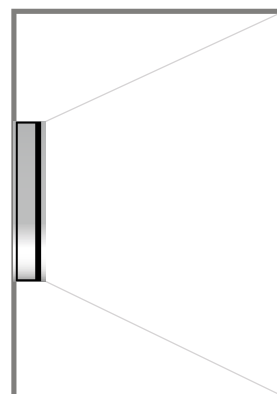
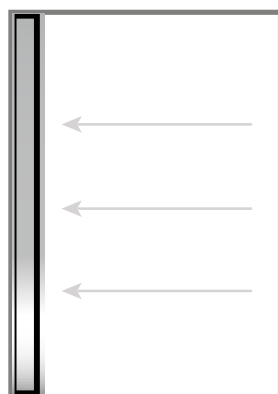
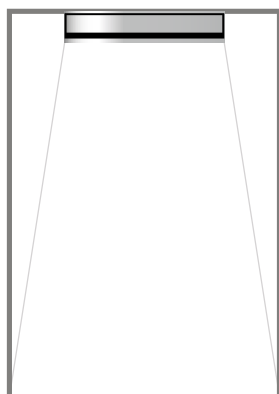
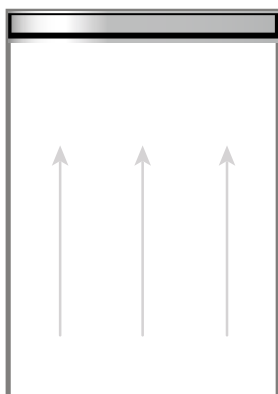

Caratteristiche

Materiale	acciaio inox spessore 20/10
Scarico	DN 50
Capacità di scarico	55 l/min
Colore	acciaio
Dimenszioni	A 80 mm x H 63 ÷ 115 mm

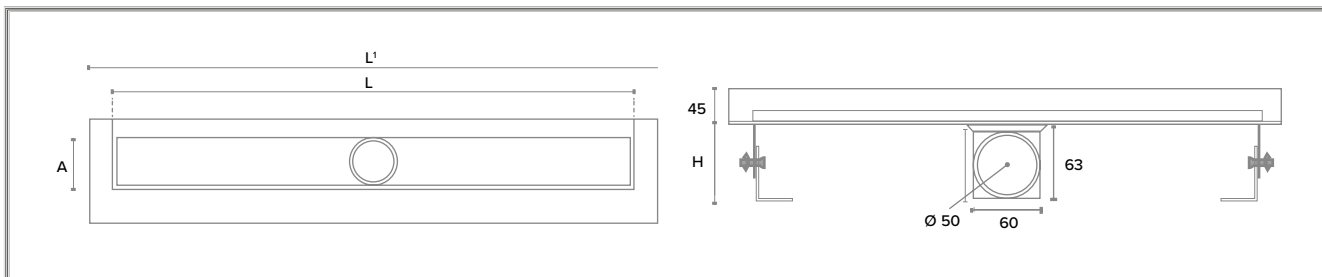

FULL INOX LUCIDO

CODICE	EURO/PZ	VERSIONE		PZ
		L (mm)	L ¹ (mm)	
603300		485	535	1
603301		585	635	1
603302		685	735	1
603303		785	835	1
603304		885	935	1
603305		985	1035	1
603306		1085	1135	1
603307		1185	1235	1

FULL INOX SATINATO

CODICE	EURO/PZ	VERSIONE		PZ
		L (mm)	L ¹ (mm)	
603308		485	535	1
603309		585	635	1
603310		685	735	1
603311		785	835	1
603312		885	935	1
603313		985	1035	1
603314		1085	1135	1
603315		1185	1235	1

FULL INOX PIASTRELLABILE

CODICE	EURO/PZ	VERSIONE		PZ
		L (mm)	L ¹ (mm)	
603380		485	535	1
603381		585	635	1
603382		685	735	1
603383		785	835	1
603384		885	935	1
603385		985	1035	1
603386		1085	1135	1
603387		1185	1235	1

FULL INOX CON INCISIONE "SQUARE 1"

CODICE	EURO/PZ	VERSIONE		PZ
		L (mm)	L ¹ (mm)	
603316		485	535	1
603317		585	635	1
603318		685	735	1
603319		785	835	1
603320		885	935	1
603321		985	1035	1
603322		1085	1135	1
603323		1185	1235	1

FULL INOX CON LASTRA IN CRISTALLO BIANCO



CODICE	EURO/PZ	VERSIONE		PZ
		L (mm)	L ¹ (mm)	
603372		485	535	1
603373		585	635	1
603374		685	735	1
603375		785	835	1
603376		885	935	1
603377		985	1035	1
603378		1085	1135	1
603379		1185	1235	1

FULL INOX CON LASTRA IN CRISTALLO NERO

CODICE	EURO/PZ	VERSIONE		PZ
		L (mm)	L ¹ (mm)	
603364		485	535	1
603365		585	635	1
603366		685	735	1
603367		785	835	1
603368		885	935	1
603369		985	1035	1
603370		1085	1135	1
603371		1185	1235	1

**Linea Luxury
Quadrata**

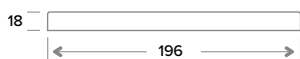
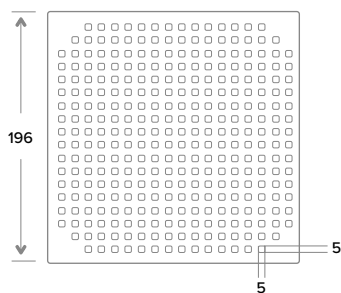
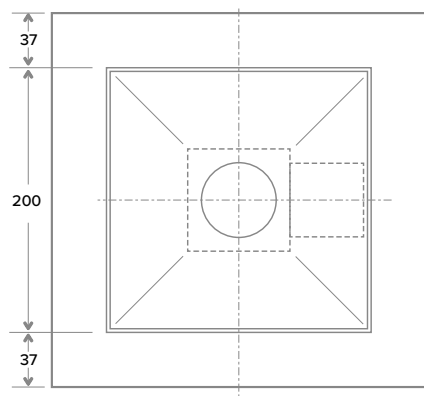
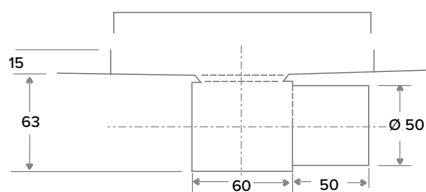
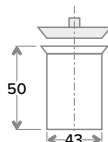
**FULL INOX CON INCISIONE "SQUARES 1"
200 X 200**



Caratteristiche

Materiale	acciaio inox spessore 20/10
Scarico	DN 50
Capacità di scarico	55 l/min
Colore	acciaio
Dimensioni	A 200 x L 200 x H 63 mm

CODICE	EURO/PZ	PZ
603090		1

**FULL INOX PIASTRELLABILE
200 X 200**

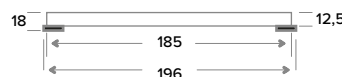
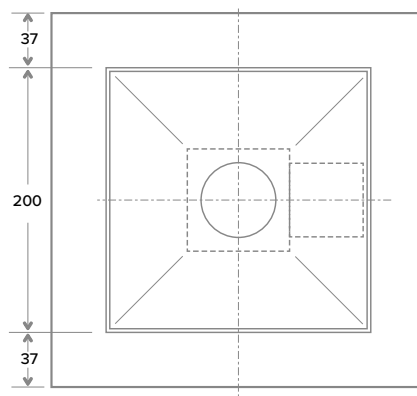
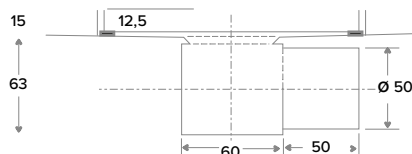
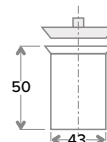

Caratteristiche

Materiale	acciaio inox spessore 20/10
Scarico	DN 50
Capacità di scarico	55 l/min
Colore	acciaio
Dimensioni	A 200 x L 200 x H 63 mm

CODICE	EURO/PZ	PZ
603091		1

Linea RAM Triangolare

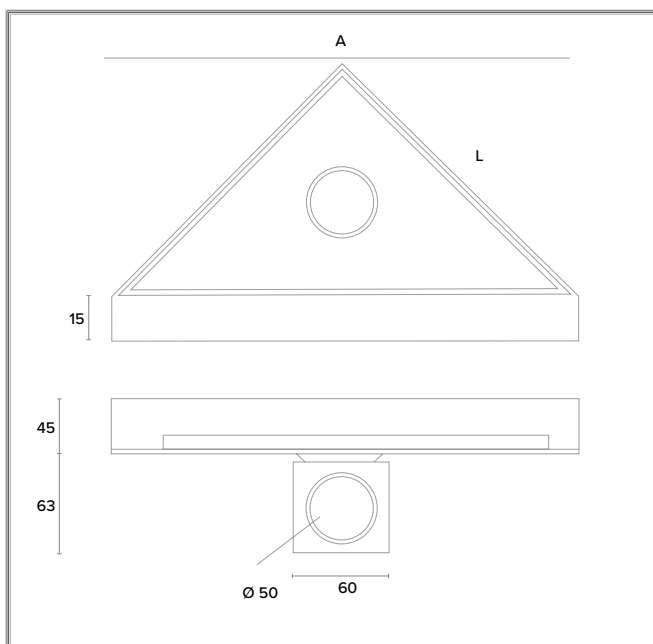

Caratteristiche

Materiale	acciaio inox spessore 20/10
Colore	acciaio
Dimenszioni	A 226 x L 315 x H 63 mm

FULL INOX CON INCISIONE "CIRCLES"



CODICE	EURO/PZ	PZ
603390		1

FULL INOX PIASTRELLABILE



CODICE	EURO/PZ	PZ
603391		1

SISTEMA DI SCARICO INOX STYLE
Chiusino sifonato
LINEA LUXURY
Quadrata

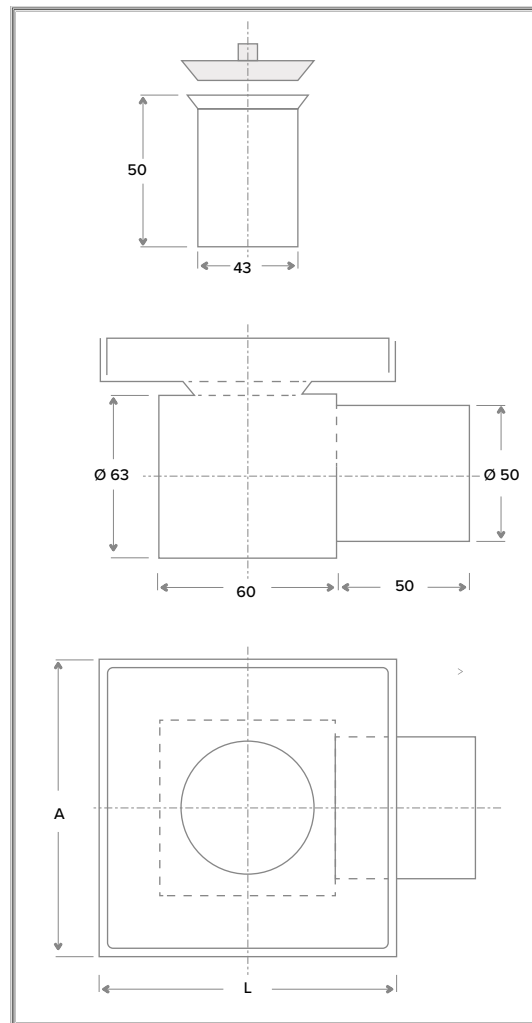

Caratteristiche

Materiale	acciaio inox spessore 20/10
Scarico	DN 50
Capacità di scarico	55 l/min
Colore	acciaio
Dimensioni	A 100 x L 100 x H 63 mm



FULL INOX CON LASTRA PIASTRELLABILE

CODICE	EURO/PZ	PZ
603116		1

FULL INOX CON INCISIONE
100 X 100



CODICE	EURO/PZ	VERSIONE	PZ
		□ Incisione	
603110		A Rectangles	1
603112		B Venice2	1
603114		C Square1	1

SISTEMA DI SCARICO PER DOCCIA INOX SLOT

La funzionalità nella sua forma più elegante e moderna racchiusa in una semplice fessura. Minimale, semplice e pulita la linea INOX SLOT è stata progettata in ogni minimo particolare per non dover scendere a compromessi tra funzionalità e design. Tutti i modelli della linea INOX SLOT sono studiati in ogni minimo particolare e possono essere agevolmente tagliati su misura direttamente in loco.

VANTAGGI

**SEZIONABILE IN
OPERA**

**ANTIBATTERICO E
ANTIMUFFA**

**ALTEZZA
REGOLABILE**

**ADATTO A PERSONE CON
DIFFICOLTÀ MOTORIE**

INOX SLOT FLOOR

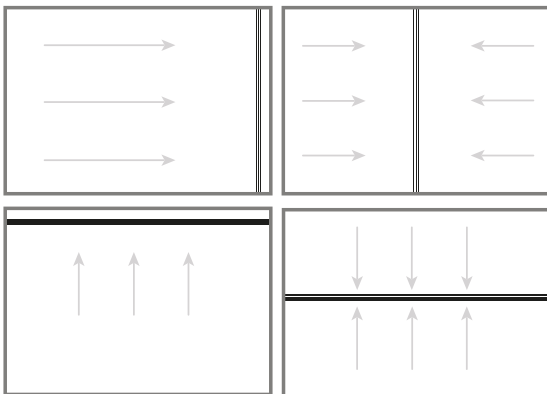

INOX SLOT WALL

Installazione a parete (con scarico verticale)

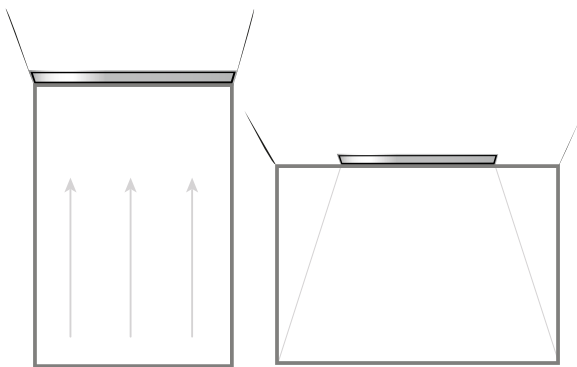

INOX SLOT FLOOR 2DS

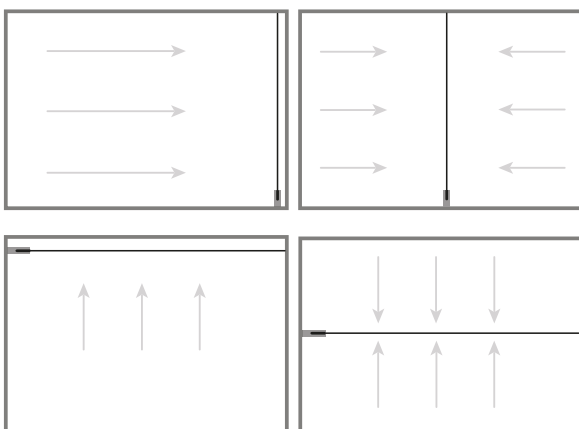

**SISTEMA DI SCARICO PER DOCCIA
INOX SLOT FLOOR**
sezionabile in opera

Caratteristiche

Materiale	acciaio inox
Scarico	DN 50
Capacità di scarico	55 l/min
Colore	acciaio
Regolazione supporto griglia	H 12 ÷ 24 mm
Altezza regolabile	64 ÷ 90 mm
Lunghezza	1000 mm

DI SERIE (INCLUSI) - confezione unica



MODULO AD INCASSO corredato di guaina e piedini di ancoraggio regolabili in altezza



Supporto della griglia regolabile in altezza da 12 a 24 mm



Progettati per essere sezionati su misura in opera



SIFONE DI SCARICO ribassato orientabile



SUPPORTO PER GRIGLIA IN REGOLABILE

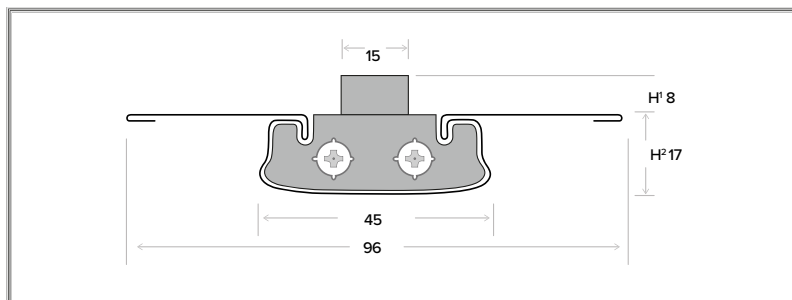
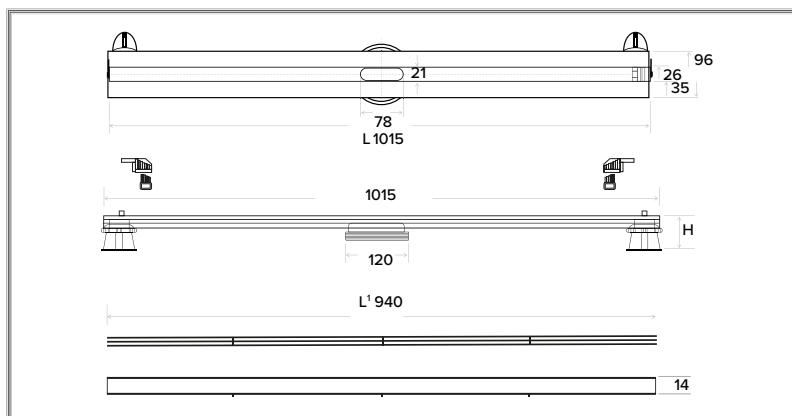

CODICE	EURO/PZ	VERSIONE					PZ
		L (mm)	L¹ (mm)	H	H¹ (mm)	H² (mm)	
603411		1015	940	64 ÷ 90	8	17	1



SISTEMA DI SCARICO PER DOCCIA INOX SLOT WALL

sezionabile in opera

Installazione a parete (con scarico verticale)

Caratteristiche

Materiale	acciaio inox
Scarico	DN 50
Capacità di scarico	55 l/min
Colore	acciaio satinato
Altezza regolabile	60 ÷ 125 mm
Lunghezza	1000 mm

DI SERIE (INCLUSI) - confezione unica



MODULO AD INCASSO corredato di guaina e piedini di ancoraggio regolabili in altezza



SUPPORTO PER GRIGLIA IN ACCIAIO INOX tagliabile su misura in opera



GRIGLIA IN ACCIAIO INOX tagliabile su misura in opera e rimovibile



GRIGLIA FERMA CAPELLI in acciaio inox



SIFONE DI SCARICO ribassato orientabile



Progettati per essere sezionati su misura in opera

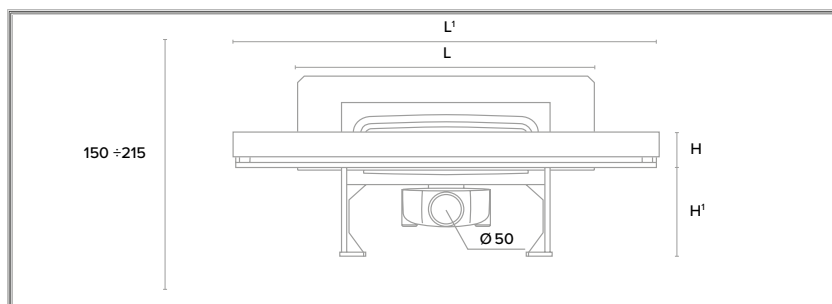
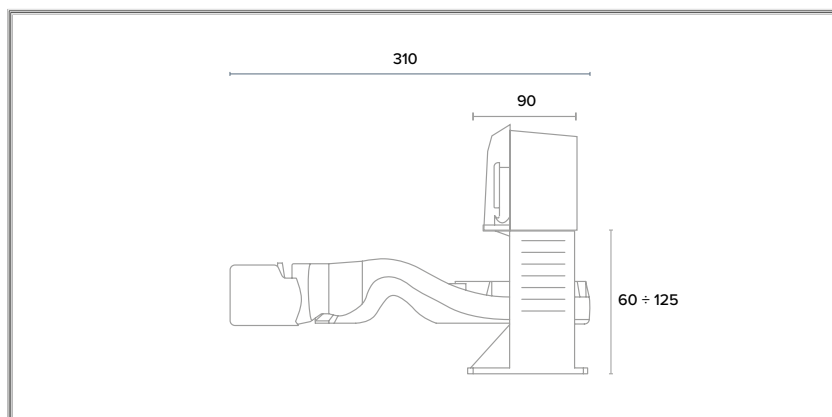

CODICE	EURO/PZ	VERSIONE				PZ
		L (mm)	L' (mm)	H (mm)	H' (mm)	
603401		295	1000	40	60 ÷ 125	1

SISTEMA DI SCARICO PER DOCCIA
INOX SLOT FLOOR 2DS
 (reversibile)



Caratteristiche

Materiale	acciaio inox
Scarico	DN 50
Capacità di scarico	55 l/min
Colore	acciaio
Altezza regolabile	64 ÷ 90 mm
Lunghezza	2000 mm



Possono essere agevolmente tagliati su misura direttamente in opera

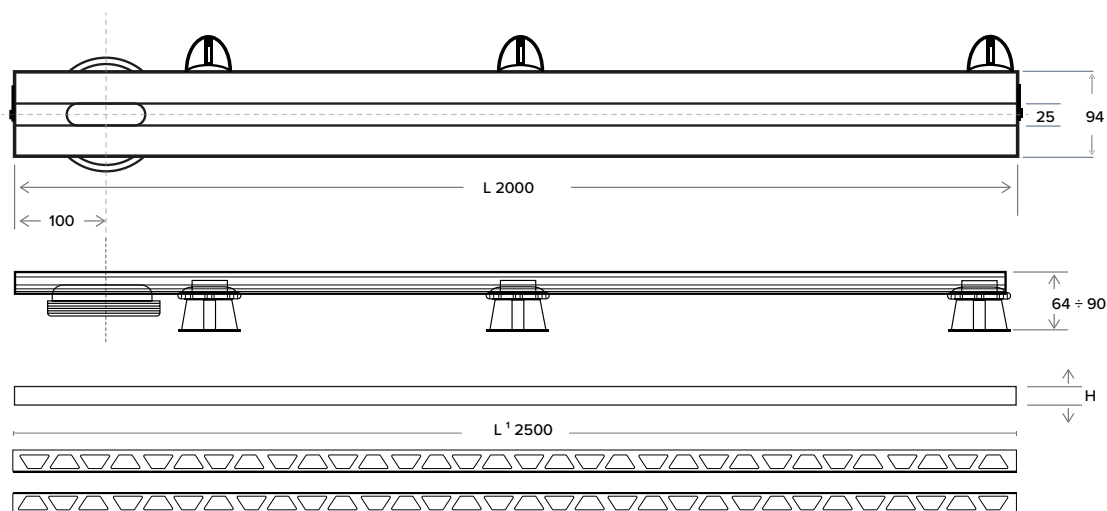



Composto da:

- Modulo ad incasso corredato di guaina e piedini di ancoraggio regolabili in altezza
- Sifone di scarico ribassato orientabile
- Griglia ferma capelli in acciaio inox
- Profili per rivestimento ceramico (vedi versione)

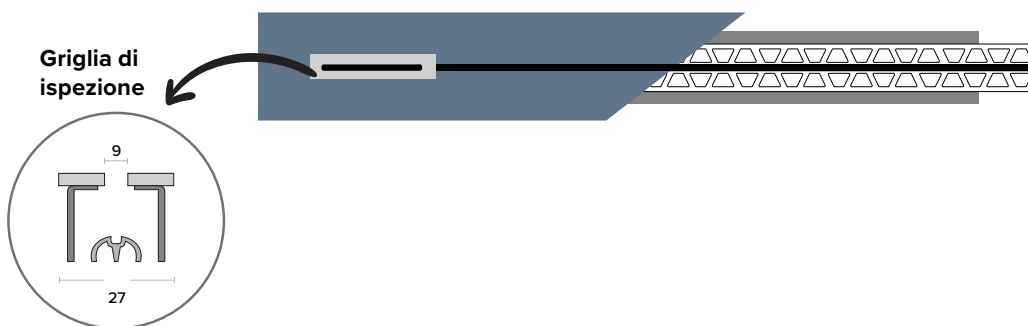
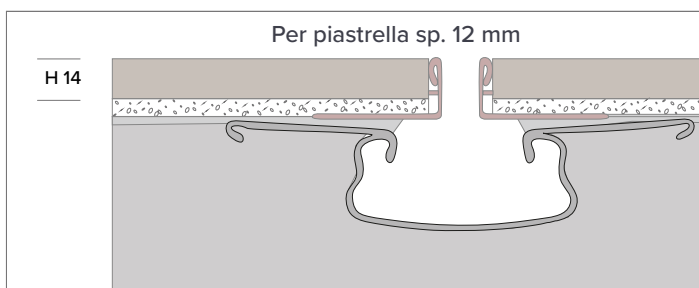
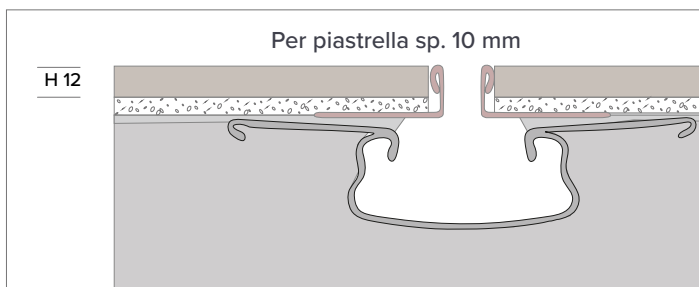
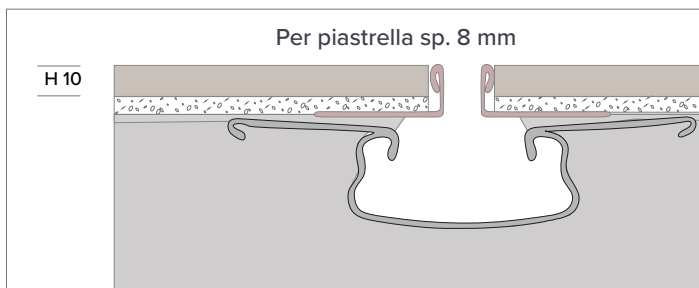
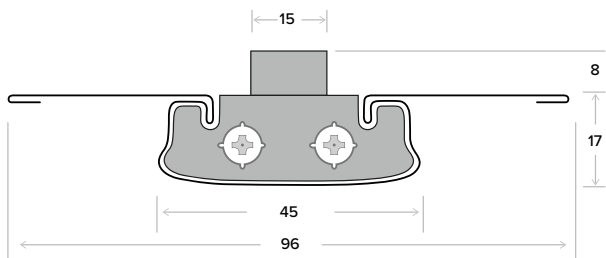

CODICE	EURO/PZ	VERSIONE		PZ
		L (mm)	H (mm)	
603415		2000	10	1
603416			12	1
603417			14	1

PROFILI DI RICAMBIO IN ACCIAIO INOX

CODICE	EURO/PZ	VERSIONE		PZ.
		L ¹ (mm)	H (mm)	
603500		2500	10 per piastrella sp. 8	1
603501			12 per piastrella sp. 10	1
603502			14 per piastrella sp. 12	1

**FLESSIBILI DOCCIA
SPRING LINE**

Unico sul mercato per la novità, per il design e per i materiali utilizzati



Realizzato in filo di acciaio inox AISI 304 di diametro 1 mm elettrolucidato e lavorato artigianalmente per ottenere quel particolare effetto cromatico. Per realizzare un flessibile doccia da un metro e mezzo vengono utilizzati 78 metri di filo di acciaio. Prodotto coperto da brevetto. Maglia non estensibile.

Caratteristiche

Materiale	acciaio inox AISI 304
Colore maglia	cromo
Finiture terminali	ottone cromato liscio

Caratteristiche

Calotta	piana liscia
Cono	liscio
Attacchi	Ø 1/2 F



CODICE	EURO/PZ	VERSIONE	PZ
		L cm	
070620		120	1
070621		150	1
070622		175	1
070623		200	1

Maglia non estensibile



Caratteristiche

Calotta	piana liscia
Cono	liscio antitorsione
Attacchi	Ø 1/2 F



CODICE	EURO/PZ	VERSIONE	PZ
		L cm	
070627		120	1
070625		150	1
070628		175	1
070626		200	1

Caratteristiche

Cono	Ø 1/2 F antitorsione
Attacco	girevole 15 x 1 M



CODICE	EURO/PZ	VERSIONE	PZ
		L cm	
070630		120	1
070631		150	1
070632		175	1
070633		200	1

Caratteristiche

Cono	liscio
Cono	liscio antitorsione
Attacchi	Ø 1/2 F



CODICE	EURO/PZ	VERSIONE	PZ
		L cm	
070627CC		120	1
070625CC		150	1
070628CC		175	1
070626CC		200	1

Caratteristiche

Cono	Ø 1/2 F liscio
Attacco	girevole 15 x 1 M



CODICE	EURO/PZ	VERSIONE	PZ
		L cm	
070635		120	1
070636		150	1
070637		175	1
070638		200	1

FLESSIBILI DOCCIA SIMPLE LINE

Pratico, semplice, funzionale

ROUND PVC

Caratteristiche

Materiale	PVC rinforzato
Sezione	circolare
Colore	argento
Finitura terminale	ottone cromato
Cono	Ø 1/2 F antitorsione
Attacco	Ø 1/2 F

CODICE	EURO/PZ	VERSIONE	PZ
		L cm	
604300		120	1
604301		150	1
604302		200	1



SQUARE PVC

Caratteristiche

Materiale	PVC rinforzato
Sezione	quadrata
Colore	argento
Finitura terminale	ottone cromato
Cono	Ø 1/2 F antitorsione
Attacco	Ø 1/2 F

CODICE	EURO/PZ	VERSIONE	PZ
		L cm	
604310		120	1
604311		150	1
604312		200	1



STEEL

Caratteristiche

Materiale	acciaio doppia aggraffatura
Colore	argento
Finitura terminale	ottone cromato
Cono	Ø 1/2 F antitorsione
Calotta	Ø 1/2 F

CODICE	EURO/PZ	VERSIONE	PZ
		L cm	
604319		120	1
604320		150	1
604321		200	1



FLESSIBILE DOCCIA ESTENSIBILE

Flessibile doccia spiralato in PVC
estensibile fino a 300 cm

Caratteristiche

Attacco	1/2"
Finitura	nero

CODICE	EURO/PZ	PZ
604325		1





SALISCENDI
WHITE SUN

Composto da:

- Asta in acciaio inox
- Supporto in ABS
- Scorrevole in ABS
- Porta oggetti
- Doccetta white Ø 150 mm a 5 funzioni
- Finitura cromo lucido/bianco
- Flessibile Linea SIMPLE L 150 cm acciaio inox doppia aggraffatura

CODICE	EURO/PZ	VERSIONE	PZ
		Dimensioni L x H mm	
605100		255 x 800	1



SALISCENDI
BLACK SUN

Composto da:

- Asta in acciaio inox
- Supporto in ABS regolabile
- Scorrevole in ABS
- Doccetta white Ø 105 mm a 5 funzioni
- Finitura cromo lucido/nero
- Flessibile Linea SIMPLE L 150 cm acciaio inox doppia aggraffatura

CODICE	EURO/PZ	VERSIONE	PZ
		Dimensioni L x H mm	
605102		160 x 735	1

**KIT DOCCIA
STEEL ROUND**

Composto da:

- Presa acqua a muro round in ottone cromato con supporto
- Braccio doccia round in ottone cromato Ø 22 x L 350 mm
- Soffione ultrapiatto round in acciaio inox AISI304
- Doccetta ispezionabile round in ottone cromato Ø 21 x L 196 mm
- Flessibile L. 150 cm (vedi pag. 38-39)

CODICE	EURO/PZ	VERSIONE		PZ
		Soffione Ø mm	Flessibile	
605201		200	Spring Line	1
605203		250		1
605205		300		1
605200		200	Round PVC	1
605202		250		1
605204		300		1

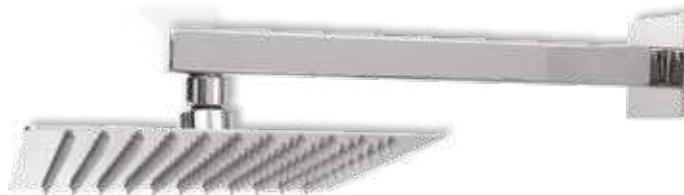
**KIT DOCCIA
STEEL SQUARE**

Composto da:

- Presa acqua a muro square in ottone cromato scomponibile con supporto square
- Braccio doccia square in ottone cromato 22 x 22 x L 350 mm
- Soffione ultrapiatto square in acciaio inox AISI 304
- Doccetta square in ottone cromato L 35 x P 15 x H 230 mm
- Flessibile L 150 cm (vedi pag. 38-39)

CODICE	EURO/PZ	VERSIONE		PZ
		Soffione □ mm	Flessibile	
605207		200x200	Spring Line	1
605209		250x250		1
605211		300x300		1
605206		200x200	Square PVC	1
605208		250x250		1
605210		300x300		1



KIT DOCCIA DUPLEX ROUND



Composto da:

- Presa acqua a muro con supporto round
- Flessibile L. 150 cm (vedi pag. 38-39)

Con doccetta in OTTONE ispezionabile

CODICE	EURO/PZ	Flessibile	Doccetta Round mm	PZ
		Simple Steel	Ø 21 x L 196	1
605222		Spring Line		1
605223		Simple Round		1

Con doccetta in ABS

CODICE	EURO/PZ	Flessibile	Doccetta Round mm	PZ
		Simple Steel	Ø 32 x L 200	1
605232		Spring Line		1
605233		Simple Round		1

KIT DOCCIA DUPLEX ROUND CON VALVOLA DI SICUREZZA



Composto da:

- Presa acqua a muro round in ottone cromato con supporto e valvola di sicurezza
- Flessibile L. 150 cm (vedi pag. 38-39)

Con doccetta in OTTONE

CODICE	EURO/PZ	VERSIONE	Doccetta Round mm	PZ
		Flessibile	Ø 21 x L 196	
		Simple Steel		1
605266		Spring Line		1
605267		Simple Round	1	

Con doccetta in ABS

CODICE	EURO/PZ	VERSIONE	Doccetta Round mm	PZ
		Flessibile	Ø 32 x L 200	
		Simple Steel		1
605260		Spring Line		1
605261		Simple Round	1	

KIT DOCCIA DUPLEX SQUARE

Composto da:

- Presa acqua a muro scomponibile in ottone comato con supporto square
- Flessibile L. 150 cm (vedi pag. 38-39)

Con doccetta in OTTONE

CODICE	EURO/PZ	VERSIONE		PZ
		Flessibile	Doccetta Square mm	
605227		Simple Steel	L 35 x P 15 x L 196	1
605228		Spring Line		1
605231		Simple Square		1

Con doccetta in ABS

CODICE	EURO/PZ	VERSIONE		PZ
		Flessibile	Doccetta Square in ABS	
605235		Simple Steel	L 35 x P 15 x L 196	1
605236		Spring Line		1
605237		Simple Square		1



KIT DOCCIA DUPLEX SQUARE CON VALVOLA DI SICUREZZA

Composto da:

- Presa acqua a muro scomponibile square in ottone cromato con supporto e valvola di sicurezza
- Flessibile L. 150 cm (vedi pag. 38-39)

Con doccetta in OTTONE

CODICE	EURO/PZ	VERSIONE		PZ
		Flessibile	Doccetta Square mm	
605269		Simple Steel	L 35 x P 15 x L 200	1
605270		Spring Line		1
605271		Simple Square		1

Con doccetta in ABS

CODICE	EURO/PZ	VERSIONE		PZ
		Flessibile	Doccetta Square mm	
605263		Simple Steel	L 35 x P 15 x L 200	1
605264		Spring Line		1
605265		Simple Square		1



KIT SHUT - OFF
ROUND CLASSIC
 SALVASPAZIO

Doccetta shut-off
 con pulsante
 ON/OFF



Pres a acqua a
 muro con attacco
 doccetta

Caratteristiche

Pres a muro | ottone cromato
 Doccetta | ottone cromato - L 140 x Ø 50 mm
 Flessibile | PVC grigio - 120 cm



Flessibile Simple Line
 ROUND

CODICE	EURO/PZ	PZ
605244		1

KIT SHUT - OFF
SQUARE CLASSIC
 SALVASPAZIO

Doccetta shut-off con
 pulsante ON/OFF



Pres a acqua a muro
 con attacco doccetta

Caratteristiche

Pres a muro | ottone cromato
 Doccetta | ottone cromato - L 140 x Ø 50 mm
 Flessibile | PVC grigio - 120 cm



Flessibile Simple Line
 SQUARE

CODICE	EURO/PZ	PZ
605248		1

KIT SHUT - OFF
ROUND FAST
 PER RUBINETTO BIDET

Doccetta shut-off con
 pulsante ON/OFF



Caratteristiche

Deviatore attacco rubinetto | ottone cromato M22 x 1 - M24 x 1
 Doccetta shut-off | ottone cromato L 140 x Ø 50 mm
 Supporto doccetta a muro | ottone cromato
 Attacco rubinetto | F22 x 1
 Flessibile | PVC grigio - 120 cm



Deviatore di flusso per
 rubinetto

CODICE	EURO/PZ	PZ
605254		1

**KIT SHUT - OFF
ROUND ELEGANT**

 Flessibile Simple Line
ROUND

Caratteristiche

Pres a muro	ottone cromato
Doccetta	ottone cromato - L 140 x Ø 50 mm
Flessibile	PVC grigio - 120 cm



CODICE	EURO/PZ	PZ
605251		1

**KIT SHUT - OFF
SQUARE ELEGANT**

 Flessibile Simple Line
SQUARE

Caratteristiche

Pres a muro	ottone cromato
Doccetta	ottone cromato - L 140 x Ø 50 mm
Flessibile	PVC grigio - 120 cm



CODICE	EURO/PZ	PZ
605253		1

**KIT IDROSCOPINO
ROUND ELEGANT**

 Flessibile Simple Line
ROUND

Caratteristiche

Pres a muro	ottone cromato
Doccetta	ottone cromato - L 140 x Ø 50 mm
Flessibile	PVC grigio - 120 cm

 Doccetta idroscopino
con pulsante
a rilascio

CODICE	EURO/PZ	PZ
605250		1

**KIT IDROSCOPINO
SQUARE ELEGANT**

 Flessibile Simple Line
SQUARE

Caratteristiche

Pres a muro	ottone cromato
Doccetta	ottone cromato - L 140 x Ø 50 mm
Flessibile	PVC grigio - 120 cm

 Doccetta
idroscopino con
pulsante a rilascio

 Pres a acqua a
muro con attacco
idroscopino
e chiusura di
sicurezza

CODICE	EURO/PZ	PZ
605252		1

SOFFIONI DOCCIA
LOW ROUND
IN ACCIAIO INOX



Soffione utrapiatto round in acciaio inox
Ugelli in silicone anticalcare autopulenti

Caratteristiche

Conforme	DM 174
Materiale	acciaio inox AISI 304
Spessore	2 mm
Attacco	1/2" F
Finitura	lucida

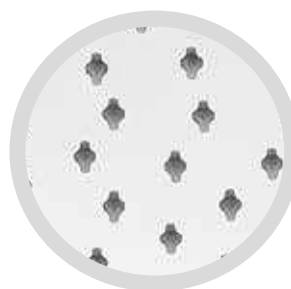

CODICE	EURO/PZ	VERSIONE		PZ
		Soffione Ø mm	Ugelli n°	
605400		100	33	1
605401		150	44	1
605402		200	90	1
605403		250	126	1
605404		300	126	1

BRACCIO DOCCIA

ROUND

Caratteristiche

Materiale	acciaio inox AISI 304
Attacco	1/2" M
Finitura	lucida



PER INSTALLAZIONE A PARETE

CODICE	EURO/PZ	VERSIONE		PZ
		Soffione Ø x L mm		
605306		22 x 300		1
605307		22 x 350		1
605308		22 x 400		1

PER INSTALLAZIONE A SOFFITTO

CODICE	EURO/PZ	VERSIONE		PZ
		Soffione Ø x L mm		
605300		22 x 100		1
605301		22 x 200		1
605302		22 x 300		1

SOFFIONI DOCCIA
LOW SQUARE
 IN ACCIAIO INOX

Soffione utrapiatto square in acciaio inox
 Ugelli in silicone anticalcare autopulenti

Caratteristiche

Conforme	DM 174
Materiale	acciaio inox AISI 304
Spessore	2 mm
Attacco	1/2" F
Finitura	lucida

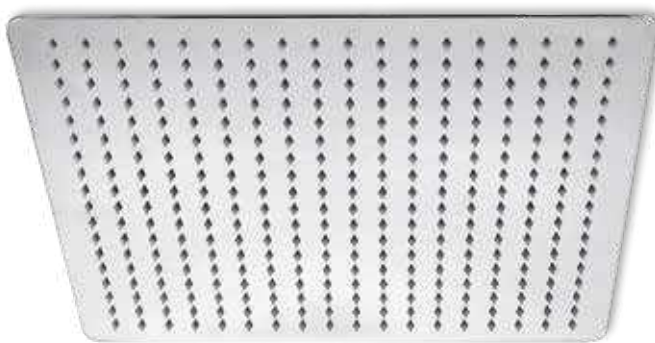

CODICE	EURO/PZ	VERSIONE		PZ
		Soffione L x L mm	Ugelli n°	
605410		100x 100	36	1
605411		150x 150	64	1
605412		200x 200	121	1
605414		250x 250	196	1
605415		300x 300	196	1
605413		200 x 300	196	1

BRACCIO DOCCIA

SQUARE

Caratteristiche

Materiale	acciaio inox AISI 304
Attacco	1/2" M
Finitura	lucida

PER INSTALLAZIONE A PARETE

CODICE	EURO/PZ	VERSIONE		PZ
		Soffione □ x L mm		
605309		25 x 300		1
605310		25 x 350		1
605311		25 x 400		1



PER INSTALLAZIONE A SOFFITTO

CODICE	EURO/PZ	VERSIONE		PZ
		Soffione □ x L mm		
605303		25 x 100		1
605304		25 x 200		1
605305		25 x 300		1



**DOCCETTA ROUND
MONOGETTO IN ABS**



Caratteristiche

Materiale	ABS anticalcare
Dimensioni	Ø 32 x L 200 mm
Attacco	1/2 M
Finitura	cromo lucida

CODICE	EURO/PZ	PZ
605518		1

**DOCCETTA SQUARE
MONOGETTO IN ABS**



Caratteristiche

Materiale	ABS anticalcare
Dimensioni	□ 25 x L 210 mm
Attacco	1/2 M
Finitura	cromo lucida

CODICE	EURO/PZ	PZ
605520		1

**DOCCETTA ROUND
MONOGETTO CROMO**

Scomponibile ed
ispezionabile



Caratteristiche

Materiale	ottone cromato
Dimensioni	Ø 21 x L 200 mm
Attacco	1/2" M
Finitura	cromo lucida

CODICE	EURO/PZ	PZ
605500		1

**DOCCETTA SQUARE
MONOGETTO CROMO**



Caratteristiche

Materiale	ottone cromato
Dimensioni	□ 35 x 15 x L 230 mm
Attacco	1/2" M
Finitura	cromo lucida

CODICE	EURO/PZ	PZ
605501		1

**DOCCETTA LOW ROUND
MONOGETTO**



Caratteristiche

Materiale	ottone cromato
Dimensioni	Ø 100 x L 232 mm
Attacco	1/2" M
Finitura	cromo lucida
Ugelli n°	33

CODICE	EURO/PZ	PZ
605502		1

**DOCCETTA LOW SQUARE
MONOGETTO**



Caratteristiche

Materiale	ottone cromato
Dimensioni	□ 10 x 8 x L 232 mm
Attacco	1/2" M
Finitura	cromo lucida
Ugelli n°	30

CODICE	EURO/PZ	PZ
605503		1

DOCCETTA 5 GETTI

Caratteristiche

Materiale	ABS anticalcare
Dimensioni	Ø 120 mm
Attacco	1/2 M
Finitura	cromo lucida

CODICE	EURO/PZ	PZ
605516		1

DOCCETTA MONOGETTO

Caratteristiche

Materiale	ABS anticalcare
Dimensioni	Ø 70 mm
Attacco	1/2 M
Finitura	cromo lucida

CODICE	EURO/PZ	PZ
605521		1

DOCCETTA 3 GETTI

Caratteristiche

Materiale	ABS anticalcare
Dimensioni	Ø 120 mm
Attacco	1/2 M
Finitura	nero/cromo

CODICE	EURO/PZ	PZ
605515		1

DOCCETTA MONOGETTO

Caratteristiche

Materiale	ABS anticalcare
Dimensioni	□ 35 x 15 x L 230 mm
Attacco	1/2 M
Finitura	cromo lucida

CODICE	EURO/PZ	PZ
605519		1

DOCCETTA SHUT-OFF

 Con pulsante
ON / OFF

ROUND

CODICE	EURO/PZ	VERSIONE	PZ
		Dimensioni Ø x H x L mm	
605504		20 x 55 x 120	1

Caratteristiche

Materiale	ottone cromato
Attacco	1/2" M
Finitura	cromo lucida

 Con pulsante di
azionamento

SQUARE

CODICE	EURO/PZ	VERSIONE	PZ
		Dimensioni □ x L mm	
605505		30 x 30 x 140	1

IDROSCOPINO

Con pulsante di azionamento

ROUND

CODICE	EURO/PZ	VERSIONE	PZ
		Dimensioni Ø x H x L mm	
605510		20 x 55 x 120	1

Caratteristiche

Materiale	ottone cromato
Attacco	1/2" M
Finitura	cromo lucida

SQUARE

CODICE	EURO/PZ	VERSIONE	PZ
		Dimensioni □ x L mm	
605511		30 x 30 x 140	1

**SUPPORTO A MURO
PER DOCCETTA**



Caratteristiche	
Materiale	ottone cromato
Finitura	Cromo lucida

CODICE	EURO/PZ	VERSIONE		PZ	
		Modello	Dimensioni mm		
605610		<input type="checkbox"/>	A Round	Ø 28 x H 40	1
605611		<input type="checkbox"/>	B Square	□ 31 x H 20 x L 40	1

DEVIATORI DI FLUSSO

**DEVIATORE DI FLUSSO
PER BRACCIO DOCCIA ROUND**



Permette di inserire una doccetta al braccio doccia senza opere murarie

Caratteristiche	
Materiale	ottone cromato
Dimensioni	Ø 40 x L 62 mm
Attacco E-U	1/2"
Finitura	Cromo lucida

CODICE	EURO/PZ	PZ
605600		1

**DEVIATORE SQUARE
UNIVERSALE**



Caratteristiche	
Materiale	ottone cromato
Dimensioni	□ 40 x L 62 mm
Attacco E-U	1/2"
Finitura	Cromo lucida

CODICE	EURO/PZ	PZ
605612		1

**DEVIATORE DI FLUSSO
PER RUBINETTO**



Permette di inserire un idroscopino al rubinetto del bidet senza opere murarie.

Caratteristiche	
Materiale	ottone cromato
Dimensioni	Ø 25 x H 56 x L 60 mm
Attacco E-U	1/2" M - M22x1 - M24x1
Finitura	Cromo lucida

CODICE	EURO/PZ	PZ
605601		1

PRESE ACQUA A MURO

**PRESA ACQUA A MURO
PER FLESSIBILE**



Caratteristiche	
Materiale	ottone cromato
Attacco E-U	1/2"MM
Finitura	Cromo lucida

CODICE	EURO/PZ	VERSIONE		PZ	
		Modello	Dimensioni mm		
605602		<input type="checkbox"/>	A Round	Ø 50 x H 24	1
605603		<input type="checkbox"/>	B Square	□ 25 x L 40	1

**PRESA ACQUA A MURO ROUND
CON PORTA DOCCETTA**



Caratteristiche	
Materiale	ottone cromato
Dimensioni	Ø 32 x H 600 mm
Attacco E-U	1/2"MM
Finitura	Cromo lucida

CODICE	EURO/PZ	PZ
605604		1

**PRESA ACQUA A MURO SQUARE
CON PORTA DOCCETTA
SCOMPONIBILE**
Caratteristiche

Materiale	ottone cromato
Dimensioni	□ 30 x L 650 mm
Attacco E-U	1/2"MM
Finitura	cromo lucida

CODICE	EURO/PZ	PZ
605605		1

**PRESA ACQUA A MURO CON PORTA DOCCETTA
E VALVOLA DI SICUREZZA**
Caratteristiche

Materiale	ottone cromato
Attacco E-U	1/2"MM
Finitura	cromo lucida

CODICE	EURO/PZ	VERSIONE		PZ	
		□	Modello		Dimensioni mm
605606		A	Round	∅ 30 x L 68	1
605607		B	Square	□ 30 x L 68	1

A

B
SIFONI
**SIFONE ARREDO ALTO
SQUARE**
Caratteristiche

Attacco	1"1/4
Finitura	ottone cromato

CODICE	EURO/PZ	PZ
603902		1

**SIFONE ARREDO BASSO
ROUND**
Caratteristiche

Attacco	1"1/4
Finitura	ottone cromato

CODICE	EURO/PZ	PZ
603901		1

**SIFONE ARREDO ALTO
ROUND**
Caratteristiche

Attacco	1"1/4
Finitura	ottone cromato

CODICE	EURO/PZ	PZ
603900		1

**FLESSIBILE ESTENSIBILE
IN ACCIAIO INOX AISI 304**
Caratteristiche

Attacco	1"1/4
Finitura	acciaio inox

CODICE	EURO/PZ	PZ
060679		1

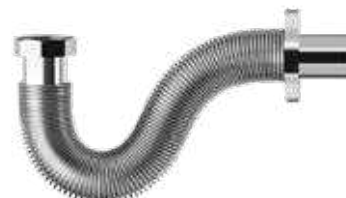

RUBINETTI PER LAVATRICI

**RUBINETTO DIRITTO
PER LAVATRICE**

Maniglia in ottone

Caratteristiche

Attacco 1/2" x 3/4"
Finitura cromata

CODICE	EURO/PZ	PZ
607025		1

**RUBINETTO A SFERA
PER LAVATRICE**

Con maniglia in ABS

Caratteristiche

Attacco 1/2" x 3/4"
Finitura cromata

CODICE	EURO/PZ	PZ
607026		1



A



B

**RUBINETTO A SFERA LUSO
PER LAVATRICE**
Caratteristiche

Attacco 1/2" x 3/4"
Finitura cromata

CODICE	EURO/PZ	VERSIONE		PZ
		<input type="checkbox"/>	Maniglia	
607027		A	ABS	1
607028		B	Metallo	1

**RUBINETTO A SQUADRA
PER LAVATRICE**

Chiusura a vitone

Caratteristiche

Attacco 1/2" x 3/4"
Finitura cromata

CODICE	EURO/PZ	PZ
607031		1

**RUBINETTO SALVASPAZIO
DOPPIO ATTACCO LAVATRICE**

Maniglia in ottone

Caratteristiche

Attacco 1/2" x 3/4"
Finitura cromata

CODICE	EURO/PZ	PZ
607029		1

**RUBINETTO SALVASPAZIO
ATTACCO LAVATRICE**

Maniglia in ottone

Caratteristiche

Attacco 1/2" x 3/4"
Finitura cromata

CODICE	EURO/PZ	PZ
607030		1

**RUBINETTO BI-USO
ATTACCO LAVATRICE**
Caratteristiche

Attacco 1/2" x 3/4"
Finitura cromata

CODICE	EURO/PZ	PZ
607032		1

RUBINETTI CASSETTE WC

RUBINETTO PER CASSETTA WC

Con maschio girevole ed estraibile
Con vite di sblocco per estrazione curvetta

Caratteristiche

Attacco 1/2" x 10 mm
Finitura cromata

CODICE	EURO/PZ	PZ
607035		1

RUBINETTO PER CASSETTA WC CON TUBETTO



Caratteristiche

Attacco 1/2" M x 3/8"
Finitura cromata

CODICE	EURO/PZ	PZ
607036		1

CANNUCCE

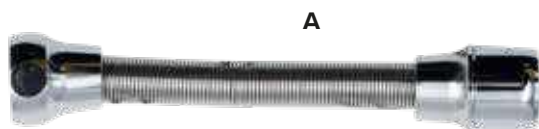
CANNUCCE



Aeratore in ottone
cromato monogetto



Aeratore in ABS
a doppio getto

Maglia in acciaio
inox AISI 304

Caratteristiche

Finitura cannuccia acciaio inox AISI 304 cromo
Finitura terminali ottone cromato
Aeratore ABS Ø 22 x 1 F
Lunghezza 150 mm

CODICE	EURO/PZ	VERSIONE		PZ
		Getto	Aeratore	
070655		A Singolo	Ottone cromato	1
070660		B Doppio	ABS	1



RUBINETTI SOTTOLAVABO



RUBINETTO SOTTOLAVABO CON FILTRO E SNODO

Funzionamento a vitone e calotta alta

Caratteristiche

Attacco 1/2" x 3/8" x 10 mm
Finitura cromata

CODICE	EURO/PZ	PZ
607023		1



RUBINETTO A SFERA SOTTOLAVABO

Con filtro e calotta alta

Caratteristiche

Attacco 1/2" x 10 mm
Finitura cromata

CODICE	EURO/PZ	PZ
607020		1



RUBINETTO A SFERA SOTTOLAVABO

Con filtro e snodo calotta alta

Caratteristiche

Attacco 1/2" x 10 mm
Finitura cromata

CODICE	EURO/PZ	PZ
607021		1



RUBINETTO SOTTOLAVABO CON FILTRO

Funzionamento a vitone e calotta alta

Caratteristiche

Attacco 1/2" x 3/8" x 10mm
Finitura cromata

CODICE	EURO/PZ	PZ
607022		1

CURVETTE SOTTOLAVABO



CURVETTA STAMPATA SOTTOLAVABO

Caratteristiche

Attacco 1/2" x 10 mm
Finitura cromata

CODICE	EURO/PZ	PZ
607010		1



A



B

CURVETTA SOTTOLAVABO

Con maschio girevole ed estraibile
Con vite di sblocco per estrazione curvetta

Caratteristiche

Attacco 1/2" x 3/8" x 10 mm
Finitura cromata

CODICE	EURO/PZ	VERSIONE		PZ
		<input type="checkbox"/>	Modello	
607011		<input type="checkbox"/>	A 45°	1
607012		<input type="checkbox"/>	B 90°	1

PILETTE CLICK CLACK



ROUND CROMATA

Caratteristiche

Attacco	1" 1/4
Altezza	H 35 mm
Finitura	Cromata

CODICE	EURO/PZ	PZ
606154		1



ROUND BASSA CROMATA

Caratteristiche

Attacco	1" 1/4
Altezza	H 25 mm
Finitura	Cromata

CODICE	EURO/PZ	PZ
606153		1



SQUARE UNIVERSALE CROMATA

Caratteristiche

Attacco	1" 1/4
Altezza	H 35 mm
Finitura	Cromata

CODICE	EURO/PZ	PZ
606155		1



BASSA CROMATA CON TROPPO PIENO

Caratteristiche

Attacco	1" 1/4
Altezza	H 35 mm
Finitura	Cromata

CODICE	EURO/PZ	VERSIONE		PZ
		<input type="checkbox"/>	Modello	
606156		A	Round	1
606157		B	Square	1



A



B

ALTA CROMATA CON TROPPO PIENO

Caratteristiche

Attacco	1" 1/4
Altezza	H 35 mm
Finitura	Cromata

CODICE	EURO/PZ	VERSIONE		PZ
		<input type="checkbox"/>	Modello	
606158		A	Round	1
606159		B	Square	1



A



B

Indice in ordine alfabetico	pagine
BOX DOCCIA	
LINEA LOFTY	2-11
LINEA ACRIL	14-17
Raccordo per due pareti doccia Walk - in	11
Accessori e ricambi per box doccia Linea Lofty	12
BRACCIO DOCCIA	
<i>Round - Square</i>	46-47
COMPLEMENTI BAGNO - ACCESSORI	
<i>Sifoni</i>	51
<i>Rubinetti per lavatrici</i>	52
<i>Rubinetti per cassette WC</i>	53
<i>Cannucce</i>	53
<i>Rubinetti sottolavabo</i>	54
<i>Curvette sottolavabo</i>	54
<i>Pilette click clack</i>	55
COMPLEMENTI DOCCIA - ACCESSORI	
<i>Supporto a muro per doccetta</i>	50
<i>Deviatori di flusso</i>	50
DOCCETTE	
<i>Monogetto e plurigetto</i>	48-49
<i>Shut - off</i>	49
<i>Idroscopino</i>	49
FLESSIBILI DOCCIA	
SPRING LINE	38
SIMPLE LINE <i>Round PVC - Square PVC - Steel</i>	39
KIT DOCCIA	
<i>Steel Round - Steel Square</i>	41
<i>Duplex Round</i>	42
<i>Duplex Square</i>	43

Indice in ordine alfabetico	pagine
KIT IDROSCOPINO	
<i>Round Elegant - Square Elegant</i>	45
KIT SHUT - OFF	
<i>Round Classic - Square Classic - Round Fast</i>	44
<i>Round Elegant - Square Elegant</i>	45
PIATTI DOCCIA	
PIATTI DOCCIA ZERO in Mineral Plane	18 - 23
Accessori e ricambi per piatti doccia ZERO	23
SALISCENDI	
<i>White Sun - Black Sun</i>	40
SALISCENDI	
<i>White Sun - Black Sun</i>	40
SISTEMA DI SCARICO A PAVIMENTO PER DOCCIA	
INOX STYLE	24-25
<i>Linea Luxury rettangolare</i>	26-27
<i>Linea Luxury quadrata</i>	30
<i>Linea Ram Rettangolare</i>	28-29
<i>Linea Ram triangolare</i>	31
<i>Chiusino sifonato quadrato</i>	32
INOX SLOT	33
<i>Linea Floor</i>	34
<i>Linea Wall</i>	35
<i>Linea Floor 2DS</i>	36-37
SOFFIONI DOCCIA	
<i>Low Round - Low Square</i>	46-47



**Per le nostre condizioni di vendita
inquadra il QR code**



SEDE: via 1° Maggio, 7 - 21012 Cassano Magnago (VA) Tel: 0331 - 20.49.11 r.a. - Fax: 0331 - 20.14.58
E-mail: ferrarivarese@ferrariwelcome.it

FILIALE: via S. Pieretto, 50 - 55060 Capannori (LU) Tel: 0583 - 941.41 r.a. - Fax: 0583 - 946.82
E-mail: ferrarilucca@ferrariwelcome.it

FILIALE: viale dell'Artigianato, 276 - 35047 Solesino (PD) Tel: 0429 - 76.72.27 - Fax: 0429 - 70.18.10
E-mail: ferraripadova@ferrariwelcome.it

SCARICA LA NOSTRA APP



APP ANDROID



APP IOS

**SEGUICI SUI NOSTRI
CANALI SOCIAL**



FACEBOOK



INSTAGRAM



YOUTUBE

Edizione aprile 2023

